

maluti DORMERS

8^{Ste} Produksieveiling

24 FEBRUARIE 2024 @ 11:00
RIETKUIL, CLOCOLAN



lewendige & aanlynveiling



*Dekades se
genetika vir jou*

ONDER BESKERMING VAN DORMER GENOOTSKAP



40 RAMME • 40 STOETOOIE • 400 KOMMERSIËLE OOIE



Nova Barletta Dormers: Lodie van Reenen & Dr. Carl Scholtz 072 597 6047
Umpukane Dormers: Peet van Rooyen 082 925 4189
OVK: JT Fourie 082 854 8620 & Pieter Cloete 082 445 1501

VEILINGREËLS

VAN TOEPASSING OP VEILINGS DEUR OOS-VRYSTAAT KAAP BEDRYF BPK 1999/004069/06 (DIE AFSLAER)

Die veiling word aangebied deur OVK, h/a as Oos-Vrystaat Kaap Bedryf Bpk, Burmanweg 123, Deal Party, Noord Einde, Port Elizabeth, 6056, wie se kontakbesonderhede soos volg is:

Tel: 041 406 7500

1. RESERWEPRYS

Die veiling word gehou onderworpe aan 'n reserweprys. Die reg word in elk geval voorbehou om aanbiedinge namens die verkoper of die afslaer te maak.

2. ARTIKEL 45(1), (2) EN (3) VAN DIE VERBRUIKERSBESKERMINGSWET NR 68 VAN 2008 (DIE WET)

Hierdie sub-artikels wat slegs in Engels beskikbaar is lui soos volg:

“(1) In this section ‘auction’ includes a sale in execution of or pursuant to a court order, to the extent that the order contemplates that the sale is to be conducted by an auction.

(2) When goods are put up for sale by auction in lots, each lot is, unless there is evidence to the contrary, regarded to be the subject of a separate transaction.

(3) A sale by auction is complete when the auctioneer announces its completion by the fall of the hammer, or in any other customary manner, and until that announcement is made a bid may be retracted.”

3. AANVANGSTYD

Die veiling sal 'n aanvang neem op die gepubliseerde tyd en sal nie later begin ten einde 'n spesifieke persoon of persone in die algemeen in staat te stel om aan die veiling deel te neem nie.

4. WAT VERKOOP WORD

Slegs die lewende hawe, wild en eiendom (die goedere) wat beskryf word in die advertensie(s) wat hierdie veiling voorafgegaan het, word op die veiling verkoop.

5. VERKOPER

Slegs goedere van 'n verkoper (insluitende gasverkopers) wat voor die veiling 'n skriftelike kontrak met die afslaer aangegaan het, word op die veiling verkoop.

6. DIE KOPER

Slegs persone wat voor die aanvang van die veiling by die afslaer geregistreer het, 'n bieërsnommer ontvang het en 'n skriftelike kontrak met die afslaer gesluit het mag op die veiling bieder. 'n Koper wat nie aan hierdie vereistes voldoen nie se bod is ongeldig en mag nie deur die afslaer aanvaar word nie.

7. ONGELDIGE AANBIEDINGE

'n Bod deur 'n koper gemaak wat nie geregistreer is as 'n koper nie, is ongeldig.

8. VOLMAGTE

Iemand wat die veiling bywoon en aanbiedinge namens 'n ander maak moet vooraf 'n skriftelike magtiging aan die afslaer voorlê waarkragtens spesifieke magtiging om aanbiedinge te maak, verleen word. Die magtiging moet die volgende besonderhede van die persoon bevat wat gestaaf moet word deur 'n identiteitsdokument of, waar geen so 'n dokument bestaan nie, in die diskresie van die afslaer, 'n ander dokument waaruit die identiteit van die persoon vasgestel kan word en waarop 'n foto van die persoon voorkom. Die

verlangde besonderhede is soos volg:

8.1 die verteenwoordiger se volle name;

8.2 sy geboortedatum;

8.3 sy identiteitsnommer;

8.4 sy woonadres; en

8.5 sy kontakbesonderhede.

In die geval waar 'n maatskappy verteenwoordig word moet die volmag op 'n briefhoof van die maatskappy verskyn en vergesel wees van 'n resoluë van die maatskappy.

9. TRUSTREKENING

Die afslaer het 'n trustrekening waarin alle geld vir die voordeel van die verkoper min die ooreengekome kommissie betaalbaar aan die afslaer en uitgawes deur die afslaer in verband met die verkope aan gegaan, gestort sal word.

10. REDE VIR DIE VEILING

Indien die rede vir die veiling anders is as die normale en vrywillige vervreemding van die goedere van die verkoper, sal die rede deur die afslaer bekend gemaak word.

11. DIE AANBIEDERSREKORD

Die afslaer hou 'n rekord van alle voornemende kopers sowel as 'n vendurool en beide die dokumente is sonder vergoeding ter insae van bywoners van die veiling beskikbaar gedurende gewone besigheidsure.

12. WEERGAWE VAN HIERDIE REËLS

Hierdie reëls is die jongste weergawe daarvan.

13. AGENTSKAP

Die afslaer verkoop die goedere as agent van die verkoper en alle inligting wat gepubliseer is in advertensies, katalogusse, biljette of dergelike dokumente is daarin vervat in opdrag van die verkoper. Slegs die verkoper is, gevolglik, aanspreeklik ingeval dit bewys word dat die inligting in enige opsig verkeerd is.

14. BETALING

14.1 Tensy skriftelike reëlings tussen die afslaer en die koper getref is vir die toestaan van krediet geskied alle verkope van goedere op die veiling teen kontant. Die koopprys is sonder enige aftrekkings en sonder dat skuldvergelyking toegepas kan word, deur die koper aan die afslaer betaalbaar onmiddellik na die toeslaan van die bod en voordat die goedere van die veilingsterrein verwyder word. Betaling sal geskied per tjek (ingeval van goedgekeurde kopers) of per elektroniese bank oorplasing deur middel van die internet geriewe wat vir hierdie doel op die veiling perseel beskikbaar is.

14.2 Die afslaer is geregtig om betaling per tjek te weier.

15. VOORBEHOUD VAN EIENDOMSREG

Die afslaer, die verkoper en die koper kom ooreen dat by die toeslaan van die bod die eiendomsreg in die goedere van die verkoper oorgedra word na die afslaer in wie dit vestig totdat die koper alle verskuldigde bedrae aan die afslaer betaal het, ongeag of die verkoping vir kontant of op krediet is. By die oorgang van eiendomsreg word alle ander regte wat die verkoper teen die koper mag hê insgelyks oorgedra aan die afslaer.

16. RISIKO

16.1 By die toeslaan van die bod gaan die risiko ten opsigte van die betrokke goedere op die koper oor. Die afslaer sal ook nie aanspreeklik wees vir enige skade of verlies wat deur lewende

hawe, wild of losgoedere na die toestaan van die bod veroorsaak word op welke wyse ookal aan enige iemand wat op die veilingsterrein teenwoordig is nie. Die koper vrywaar die afslaer teen aanspreeklikheid vir enige sodanige skade.

16.2 In alle omstandighede sal die afslaer nooit teenoor enige van die ander partye aanspreeklik wees vir die betaling van gevolgskaade nie.

17. DISPUTE

17.1 Ingeval daar enige geskil ontstaan met betrekking tot enige aanbieding(s) is die afslaer geregtig om alle aanbiedings op daardie betrokke goedere tot op daardie stadium onverwyld nietig te verklaar en van nuuts af aanbiedinge te vra.

17.2 Ingeval van 'n geskil oor die uitleg of toepassing van hierdie reëls is die beslissing van die afslaer finaal.

18. VERWYDERING

Die koper is verplig om, sonder versuim, na afhandeling van die veiling, die goedere van die veilingsterrein op sy koste te verwyder.

19. ONROERENDE EIENDOM

Indien onroerende eiendom op die veiling opgeveil word is dit die verkoper se verpligting om toe te sien dat die koper wie se bod aanvaar word met hom 'n skriftelike kontrak aangaan vir die verkoop van die eiendom.

20. DIE VEILINGSTERREIN

Alle persone wat die veilingsterrein betree doen dit op eie risiko en die afslaer is nie verantwoordelik vir enige beserings, skade of verliese van watter aard ookal en ontstaande uit watter skuldoorsaak ookal wat 'n persoon mag ly of opdoen terwyl hy op die terrein is nie.

21. WILD

Aanbiedinge word deur kopers gemaak per dier van 'n bepaalde spesie en as die bod toegeslaan

word neem die koper die hele lot.

22. SERTIFIKAAT

Die afslaer sertifiseer hiermee dat hierdie reëls na die beste van sy wete voldoen aan die regulasies wat uitgevaardig is ingevolge die Wet.

23. REG VAN TOEGANG TOT VEILINGSTERREIN VOORBEHOU

Die afslaer behou die reg voor om binne sy diskresie enige persoon toegang tot die veilingsterrein te weier.

24. KONTANT HANTERINGSFOOI

Indien met kontant betaal word en bedrag meer as R500 000 beloop, word 'n kontant hanteringsfooi van 1% gehef.

25. WOORDOMSKRYWING

In hierdie reëls:

25.1 sluit die manlik die vroulik in en omgekeerd; en die enkelvoud die meervoud; en

25.2 is 'n verwysing na 'n persoon, waar toepaslik ook van toepassing op 'n regs persoon of enige ander entiteit insluitende trusts en vennootskappe.

OP LAS DIE AFSLAER



**LOT 1 (M)****NB 220297**

NOVA BARLETTA RAM NB220297



Herd Book	SP
Birth date	2022-03-17
Age	1.9 years
Inbreeding	11.53%
Birth Stat.	1
Progeny	None

NB 180463 (3)
NOVA BARLETTA RECYCLE

Parentage Sire Dam
DNA
Genomic

NB 180026 (3)
NOVA BARLETTA EWE NB180026
AFL 16.7 | ILP 354 | EPI 121
Lambd 5 | Lambs 9 | Weaned 8

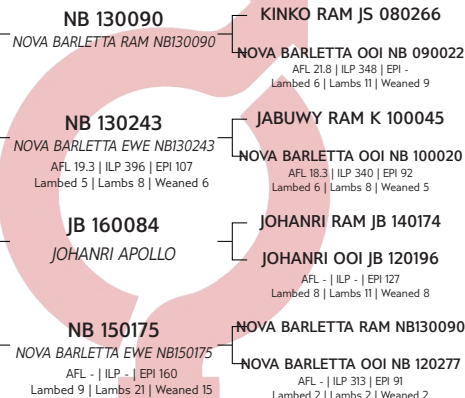

Growth			Reproduction			
Wn. Dir.	Wean Mat.	Post-Wn.	NLW	TWW	AFL	ILP
95	106	79	92	92	100	103
64%	54%	55%	43%	43%	41%	33%



EBV Analysis 2024-02-02

Logix Merit Index	97
Growth Index	101
Reproduction Index	99

SELLER REMARKS:

NOVA BARLETTA BOERDERY



Clocolan, Free State

0725976047

novabarletta@gmail.com

LOT 2 (M)**NB 220047**

NOVA BARLETTA RAM NB220047



Herd Book	SP
Birth date	2022-03-14
Age	1.9 years
Inbreeding	4.47%
Birth Stat.	2
Progeny	None

JS 180231 (1)
KINKO RAM JS 180231

Parentage Sire Dam
DNA
Genomic

NB 200521 (3)
NOVA BARLETTA EWE NB200521
AFL 20.5 | ILP - | EPI 97
Lambd 1 | Lambs 2 | Weaned 2

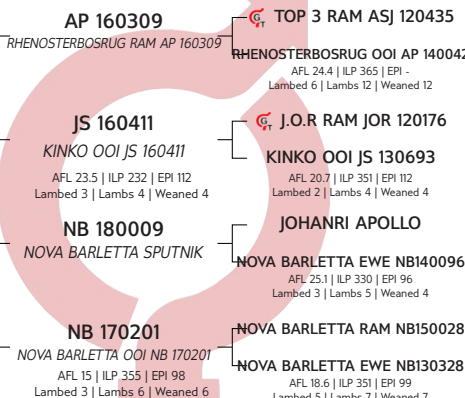

Growth			Reproduction			
Wn. Dir.	Wean Mat.	Post-Wn.	NLW	TWW	AFL	ILP
118	81	117	107	107	114	95
62%	55%	52%	43%	43%	45%	29%



EBV Analysis 2024-02-02

Logix Merit Index	117
Growth Index	112
Reproduction Index	105

SELLER REMARKS:

NOVA BARLETTA BOERDERY



Clocolan, Free State

0725976047

novabarletta@gmail.com

LOT 3 (M)**NB 220181**

NOVA BARLETTA RAM NB220181



Herd Book	SP
Birth date	2022-03-15
Age	1.9 years
Inbreeding	6.94%
Birth Stat.	3
Progeny	None

NB 200104 (3)
NOVA BARLETTA ARMSTRONG

Parentage Sire Dam
DNA
Genomic

NB 160167 (3)
NOVA BARLETTA EWE NB160167
AFL 18.8 | ILP 332 | EPI 141
Lambd 7 | Lambs 13 | Weaned 13

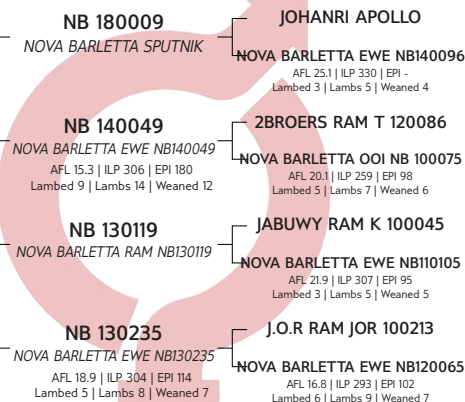

Growth			Reproduction			
Wn. Dir.	Wean Mat.	Post-Wn.	NLW	TWW	AFL	ILP
101	92	103	108	108	92	108
64%	54%	45%	42%	42%	39%	29%



EBV Analysis 2024-02-02

Logix Merit Index	104
Growth Index	100
Reproduction Index	104

SELLER REMARKS:

NOVA BARLETTA BOERDERY



Clocolan, Free State

0725976047

novabarletta@gmail.com

LOT 4 (M)



NOVA BARLETTA BOERDERY

Clocolan, Free State
0725976047
novabarletta@gmail.com

NB 220025

NOVA BARLETTA RAM NB220025



Kuddeboek	SP
Geb. dtm	2022-03-13
Oud.	1.9 jaar
Inteling	4.97%
Geb. Status	2
Nageslag	
Geen	

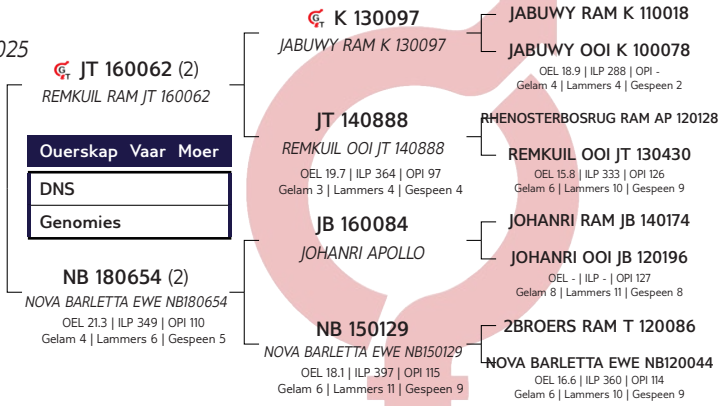

Groei			Reproduksie			
Spn. Dir.	Spn. Mat.	Na-Spn.	GLS	TWW	OEL	ILP
112	94	116	97	97	84	94
63%	59%	56%	51%	51%	49%	40%



EBV Analise 2024-02-02

Logix Meriete Indeks	105
Groei Indeks	112
Reproduksie Indeks	93

VERKOPER OPMERKINGS:

LOT 5 (M)



NOVA BARLETTA BOERDERY

Clocolan, Free State
0725976047
novabarletta@gmail.com

NB 220172

NOVA BARLETTA RAM NB220172



Kuddeboek	SP
Geb. dtm	2022-03-15
Oud.	1.9 jaar
Inteling	4.22%
Geb. Status	2
Nageslag	
Geen	

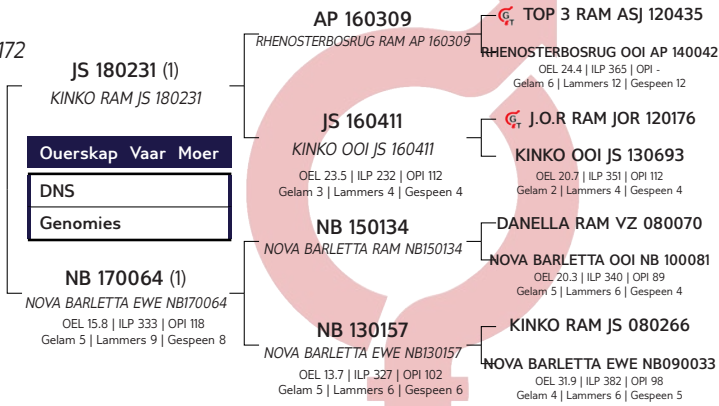

Groei			Reproduksie			
Spn. Dir.	Spn. Mat.	Na-Spn.	GLS	TWW	OEL	ILP
115	94	112	107	107	107	103
63%	57%	57%	45%	45%	44%	30%



EBV Analise 2024-02-02

Logix Meriete Indeks	119
Groei Indeks	115
Reproduksie Indeks	111

VERKOPER OPMERKINGS:

LOT 6 (M)



UMPUKANE DORMERS

Clocolan, Free State
peet@umpukane.co.za

PHR 220008

PHR RAM PHR 220008



Kuddeboek	SP
Geb. dtm	2022-04-10
Oud.	1.9 jaar
Inteling	6.41%
Geb. Status	1
Nageslag	
Geen	

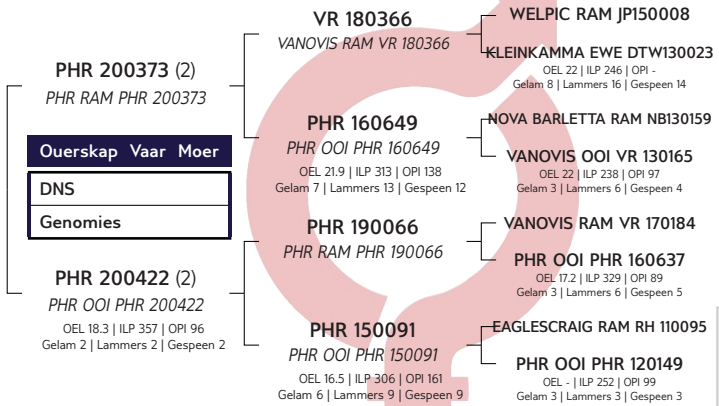

Groei			Reproduksie			
Spn. Dir.	Spn. Mat.	Na-Spn.	GLS	TWW	OEL	ILP
117	91	115	99	99	110	101
78%	51%	39%	35%	35%	35%	21%



EBV Analise 2024-02-02

Logix Meriete Indeks	115
Groei Indeks	115
Reproduksie Indeks	103

VERKOPER OPMERKINGS:



LOT 7 (M)



UMPUKANE DORMERS

Clocolan, Free State
peet@umpukane.co.za

PHR 220109

PHR RAM PHR 220109

Herd Book	SP
Birth date	2022-10-06
Age	1.4 years
Inbreeding	8.79%
Birth Stat.	2
Progeny	None



PHR 200411 (3)
PHR RAM PHR 200411

Parentage Sire Dam

DNA

Genomic

PHR 180242 (2)
PHR OOI PHR 180242
AFL 25.7 | ILP 366 | EPI 114
Lambded 3 | Lambs 7 | Weaned 7

PHR 190066
PHR RAM PHR 190066

PHR 180161
PHR OOI PHR 180161
AFL 17.6 | ILP 334 | EPI 114
Lambded 4 | Lambs 7 | Weaned 7

JOR 160014
J.O.R RAM JOR 160014

PHR 170015
PHR OOI PHR 170015
AFL 17.2 | ILP 237 | EPI 101
Lambded 2 | Lambs 4 | Weaned 4

VANOVIS RAM VR 170184

PHR OOI PHR 160637
AFL 17.2 | ILP 329 | EPI -
Lambded 3 | Lambs 6 | Weaned 5

VAN ROOYEN RAM GV 150032

PHR OOI PHR 150243
AFL 16.1 | ILP 346 | EPI 129
Lambded 8 | Lambs 13 | Weaned 9

KALKVLEY RAM CG140082

J.O.R OOI JOR 140095
AFL 23.2 | ILP 402 | EPI 130
Lambded 5 | Lambs 9 | Weaned 9

VAN ROOYEN RAM GV 150032

PHR OOI PHR 130006
AFL 16.8 | ILP 252 | EPI 145
Lambded 9 | Lambs 17 | Weaned 17

Growth			Reproduction			
Wn. Dir.	Wean Mat.	Post-Wn.	NLW	TWW	AFL	ILP
99	94	98	97	97	101	115
60%	46%	39%	31%	31%	26%	22%



EBV Analysis 2024-02-02

Logix Merit Index **100**

Growth Index **100**

Reproduction Index **98**

SELLER REMARKS:

LOT 8 (M)



UMPUKANE DORMERS

Clocolan, Free State
peet@umpukane.co.za

PHR 220162

PHR RAM PHR 220162

Herd Book	SP
Birth date	2022-10-24
Age	1.3 years
Inbreeding	4.6%
Birth Stat.	2
Progeny	None



PHR 200373 (2)
PHR RAM PHR 200373

Parentage Sire Dam

DNA

Genomic

PHR 200253 (2)
PHR OOI PHR 200253
AFL 33.1 | ILP - | EPI 92
Lambded 1 | Lambs 2 | Weaned 2

VR 180366
VANOVIS RAM VR 180366

PHR 160649
PHR OOI PHR 160649
AFL 21.9 | ILP 313 | EPI 138
Lambded 7 | Lambs 13 | Weaned 12

PHR 180062
PHR RAM PHR 180062

PHR 140351
PHR OOI PHR 140351
AFL 20.9 | ILP 270 | EPI 218
Lambded 8 | Lambs 13 | Weaned 12

WELPIC RAM JP150008

KLEINKAMMA EWE DTW130023
AFL 22 | ILP 246 | EPI -
Lambded 8 | Lambs 16 | Weaned 14

NOVA BARLETTA RAM NB130159

VANOVIS OOI VR 130165
AFL 22 | ILP 238 | EPI 97
Lambded 3 | Lambs 6 | Weaned 4

J.O.R RAM JOR 160014

VANOVIS EWE VR160414
AFL 20.4 | ILP - | EPI 89
Lambded 1 | Lambs 2 | Weaned 2

EAGLESCRAIG RAM RH 110095

PHR OOI PHR 110116
AFL - | ILP 245 | EPI 112
Lambded 4 | Lambs 7 | Weaned 7

Growth			Reproduction			
Wn. Dir.	Wean Mat.	Post-Wn.	NLW	TWW	AFL	ILP
107	93	107	99	99	105	111
59%	48%	37%	33%	33%	33%	20%



EBV Analysis 2024-02-02

Logix Merit Index **108**

Growth Index **107**

Reproduction Index **103**

SELLER REMARKS:

LOT 9 (M)



UMPUKANE DORMERS

Clocolan, Free State
peet@umpukane.co.za

PHR 220160

PHR RAM PHR 220160

Herd Book	SP
Birth date	2022-10-23
Age	1.3 years
Inbreeding	4.75%
Birth Stat.	2
Progeny	None



PHR 200373 (2)
PHR RAM PHR 200373

Parentage Sire Dam

DNA

Genomic

PHR 200222 (2)
PHR OOI PHR 200222
AFL 20 | ILP 378 | EPI 112
Lambded 3 | Lambs 5 | Weaned 4

VR 180366
VANOVIS RAM VR 180366

PHR 160649
PHR OOI PHR 160649
AFL 21.9 | ILP 313 | EPI 138
Lambded 7 | Lambs 13 | Weaned 12

CG 160020
KALKVLEY RAM CG160020

PHR 140011
PHR OOI PHR 140011
AFL 16.6 | ILP 277 | EPI 167
Lambded 7 | Lambs 12 | Weaned 12

WELPIC RAM JP150008

KLEINKAMMA EWE DTW130023
AFL 22 | ILP 246 | EPI -
Lambded 8 | Lambs 16 | Weaned 14

NOVA BARLETTA RAM NB130159

VANOVIS OOI VR 130165
AFL 22 | ILP 238 | EPI 97
Lambded 3 | Lambs 6 | Weaned 4

JOHANRI RAM JB 140017

KALKVLEY OOI CG 130046
AFL 17.8 | ILP 420 | EPI 108
Lambded 5 | Lambs 6 | Weaned 6

EAGLESCRAIG RAM RH 110095

PHR OOI PHR 100085
AFL - | ILP 238 | EPI 95
Lambded 3 | Lambs 3 | Weaned 3

Growth			Reproduction			
Wn. Dir.	Wean Mat.	Post-Wn.	NLW	TWW	AFL	ILP
105	90	108	96	96	104	105
61%	51%	38%	38%	38%	37%	24%



EBV Analysis 2024-02-02

Logix Merit Index **103**

Growth Index **103**

Reproduction Index **96**

SELLER REMARKS:



LOT 10 (M)



PHR 220075

PHR RAM PHR 220075



Kuddeboek	SP
Geb. dtm	2022-09-25
Oud.	1.4 jaar
Inteling	9.21%
Geb. Status	2
Nageslag	
Geen	

PHR 200411 (3)
PHR RAM PHR 200411

Uerskap Vaar Moer
DNS
Genomies

PHR 210039 (2)
PHR OOI PHR 210039
OEL 17.9 | ILP 376 | OPI 106
Gelum 2 | Lammers 4 | Gespeen 4

PHR 190066
PHR RAM PHR 190066

PHR 180161
PHR OOI PHR180161
OEL 17.6 | ILP 334 | OPI 114
Gelum 4 | Lammers 7 | Gespeen 7

SWH 180188
SWH RAM SWH180188

PHR 190160
PHR OOI PHR 190160
OEL 19.7 | ILP 408 | OPI 117
Gelum 3 | Lammers 7 | Gespeen 6

VANOVIS RAM VR 170184

PHR OOI PHR 160637
OEL 17.2 | ILP 329 | OPI -
Gelum 3 | Lammers 6 | Gespeen 5

VAN ROOYEN RAM GV 150032

PHR OOI PHR 150243
OEL 16.1 | ILP 346 | OPI 129
Gelum 8 | Lammers 13 | Gespeen 9

JOHANRI RAM JB 130074 BARNARD

JOHANRI OOI JB170008
OEL 16.3 | ILP 576 | OPI 96
Gelum 2 | Lammers 2 | Gespeen 2

VANOVIS RAM VR 170184

PHR OOI PHR 130070
OEL 16.9 | ILP 248 | OPI 146
Gelum 9 | Lammers 14 | Gespeen 14

Groeï			Reproduksie			
Spn. Dir.	Spn. Mat.	Na-Spn.	GLS	TWW	OEL	ILP
94	97	94	100	100	104	91
59%	43%	38%	29%	29%	26%	21%



EBV Analise 2024-02-02

Logix Meriete Indeks **97**

Groeï Indeks **96**

Reproduksie Indeks **100**

VERKOPER OPMERKINGS:

LOT 11 (M)



NB 220509

NOVA BARLETTA RAM NB220509



Kuddeboek	SP
Geb. dtm	2022-06-20
Oud.	1.7 jaar
Inteling	4.84%
Geb. Status	1
Nageslag	
Geen	

DZ 200265 (3)
DROERIVIER RAM DZ 200265

Uerskap Vaar Moer
DNS
Genomies

NB 180032 (2)
NOVA BARLETTA EWE NB180032
OEL 16.7 | ILP 344 | OPI 137
Gelum 5 | Lammers 10 | Gespeen 10

DZ 190119
DROERIVIER RAM DZ 190119

DZ 170032
DROERIVIER OOI DZ 170032
OEL 16.6 | ILP 702 | OPI 110
Gelum 5 | Lammers 11 | Gespeen 11

NB 130090
NOVA BARLETTA RAM NB130090

NB 120124
NOVA BARLETTA EWE NB120124
OEL 14.9 | ILP 274 | OPI 121
Gelum 7 | Lammers 10 | Gespeen 10

WELPIC RAM JP170020

DROERIVIER OOI DZ 150239
OEL 16.1 | ILP 245 | OPI -
Gelum 7 | Lammers 10 | Gespeen 10

DROERIVIER RAM DZ 140017

DROERIVIER OOI DZ 160038
OEL 13.8 | ILP - | OPI 87
Gelum 1 | Lammers 2 | Gespeen 2

KINKO RAM JS 080266

NOVA BARLETTA OOI NB 090022
OEL 21.8 | ILP 348 | OPI 123
Gelum 6 | Lammers 11 | Gespeen 9

JABUWY RAM K 100045

NOVA BARLETTA OOI NB 110042
OEL 12.9 | ILP 269 | OPI 84
Gelum 6 | Lammers 8 | Gespeen 4

Groeï			Reproduksie			
Spn. Dir.	Spn. Mat.	Na-Spn.	GLS	TWW	OEL	ILP
105	110	99	111	111	106	119
60%	48%	34%	38%	38%	34%	28%



EBV Analise 2024-02-02

Logix Meriete Indeks **120**

Groeï Indeks **112**

Reproduksie Indeks **125**

VERKOPER OPMERKINGS:

LOT 12 (M)



NB 220673

NOVA BARLETTA RAM NB220673



Kuddeboek	SP
Geb. dtm	2022-08-21
Oud.	1.5 jaar
Inteling	11.34%
Geb. Status	1
Nageslag	
Geen	

NB 200683 (2)
NOVA BARLETTA FALCON

Uerskap Vaar Moer
DNS
Genomies

NB 200319 (2)
NOVA BARLETTA EWE NB200319
OEL 17.3 | ILP 310 | OPI 103
Gelum 3 | Lammers 3 | Gespeen 3

NB 180009
NOVA BARLETTA SPUTNIK

NB 190500
NOVA BARLETTA EWE NB190500
OEL - | ILP - | OPI 128
Gelum 2 | Lammers 8 | Gespeen 7

JB 160084
JOHANRI APOLLO

NB 150175
NOVA BARLETTA EWE NB150175
OEL - | ILP - | OPI 160
Gelum 9 | Lammers 21 | Gespeen 15

JOHANRI APOLLO

NOVA BARLETTA EWE NB140096
OEL 25.1 | ILP 330 | OPI -
Gelum 3 | Lammers 5 | Gespeen 4

ZBROERS RAM T 160050

NOVA BARLETTA EWE NB130192
OEL 21.5 | ILP 361 | OPI 121
Gelum 5 | Lammers 9 | Gespeen 8

JOHANRI RAM JB 140174

JOHANRI OOI JB 120196
OEL - | ILP - | OPI 127
Gelum 8 | Lammers 11 | Gespeen 8

NOVA BARLETTA RAM NB130090

NOVA BARLETTA OOI NB 120277
OEL - | ILP 313 | OPI 91
Gelum 2 | Lammers 2 | Gespeen 2

Groeï			Reproduksie			
Spn. Dir.	Spn. Mat.	Na-Spn.	GLS	TWW	OEL	ILP
111	102	105	105	105	107	95
62%	48%	41%	39%	39%	37%	31%



EBV Analise 2024-02-02

Logix Meriete Indeks **117**

Groeï Indeks **115**

Reproduksie Indeks **114**

VERKOPER OPMERKINGS:

LOT 13 (M)



NOVA BARLETTA BOERDERY



Clocolan, Free State

0725976047

novabarletta@gmail.com

NB 220668

NOVA BARLETTA RAM NB220668



Herd Book	SP
Birth date	2022-08-21
Age	1.5 years
Inbreeding	9.7%
Birth Stat.	1
Progeny	
None	

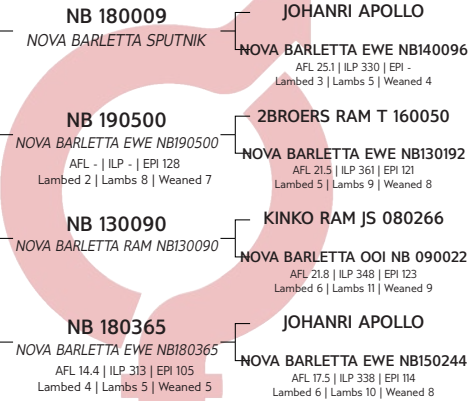
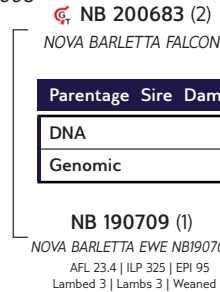

Growth			Reproduction			
Wn. Dir.	Wean Mat.	Post-Wn.	NLW	TWW	AFL	ILP
109	103	105	99	99	104	104
61%	47%	42%	38%	38%	36%	30%



EBV Analysis 2024-02-02

Logix Merit Index	113
Growth Index	114
Reproduction Index	108

SELLER REMARKS:

LOT 14 (M)



NOVA BARLETTA BOERDERY



Clocolan, Free State

0725976047

novabarletta@gmail.com

NB 220396

NOVA BARLETTA RAM NB220396



Herd Book	SP
Birth date	2022-06-18
Age	1.7 years
Inbreeding	6.27%
Birth Stat.	2
Progeny	
None	

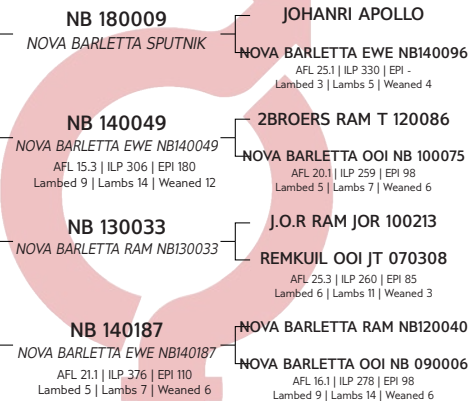
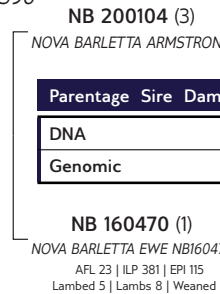

Growth			Reproduction			
Wn. Dir.	Wean Mat.	Post-Wn.	NLW	TWW	AFL	ILP
100	95	99	105	105	115	99
63%	52%	45%	40%	40%	37%	27%



EBV Analysis 2024-02-02

Logix Merit Index	107
Growth Index	101
Reproduction Index	109

SELLER REMARKS:

LOT 15 (M)



NOVA BARLETTA BOERDERY



Clocolan, Free State

0725976047

novabarletta@gmail.com

NB 220345

NOVA BARLETTA RAM NB220345



Herd Book	SP
Birth date	2022-06-17
Age	1.7 years
Inbreeding	9.71%
Birth Stat.	1
Progeny	
None	

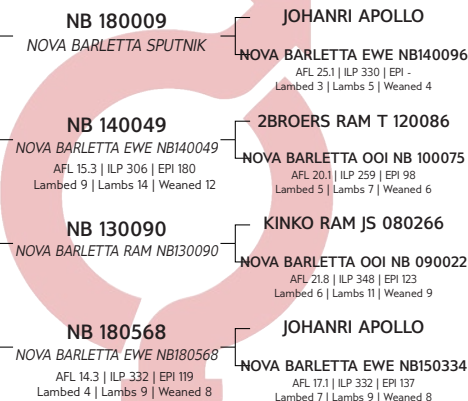
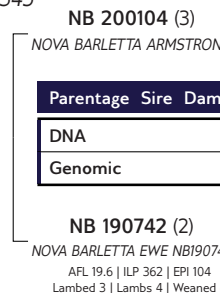

Growth			Reproduction			
Wn. Dir.	Wean Mat.	Post-Wn.	NLW	TWW	AFL	ILP
114	97	110	99	99	110	101
62%	51%	44%	41%	41%	40%	30%



EBV Analysis 2024-02-02

Logix Merit Index	115
Growth Index	116
Reproduction Index	107

SELLER REMARKS:

LOT 16 (M)



UMPUKANE DORMERS

Clocolan, Free State
peet@umpukane.co.za

PHR 220204

PHR RAM PHR 220204



Kuddeboek	SP
Geb. dtm	2022-11-08
Oud.	1.3 jaar
Inteling	4.27%
Geb. Status	2
Nageslag	
Geen	

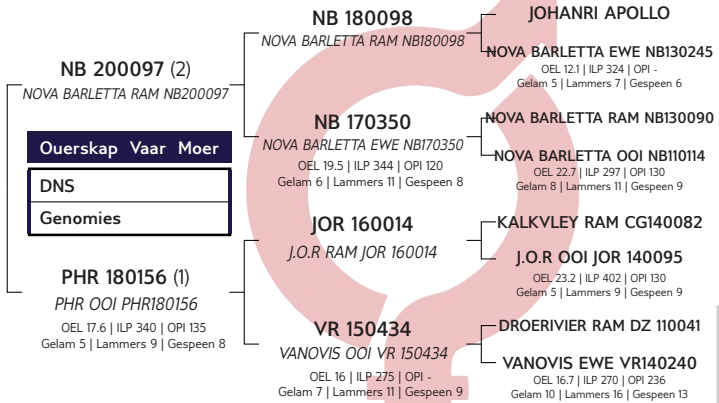

Groeï			Reproduksie			
Spn. Dir.	Spn. Mat.	Na-Spn.	GLS	TWW	OEL	ILP
100	101	97	84	84	103	116
58%	45%	33%	34%	34%	28%	24%

LOGIX
GENETICS / GENETIKA
EBV Analise 2024-02-02

Logix Meriete Indeks	97
Groeï Indeks	104
Reproduksie Indeks	92

VERKOPER OPMERKINGS:

LOT 17 (M)



UMPUKANE DORMERS

Clocolan, Free State
peet@umpukane.co.za

PHR 220099

PHR RAM PHR 220099



Kuddeboek	SP
Geb. dtm	2022-10-03
Oud.	1.4 jaar
Inteling	7.25%
Geb. Status	2
Nageslag	
Geen	

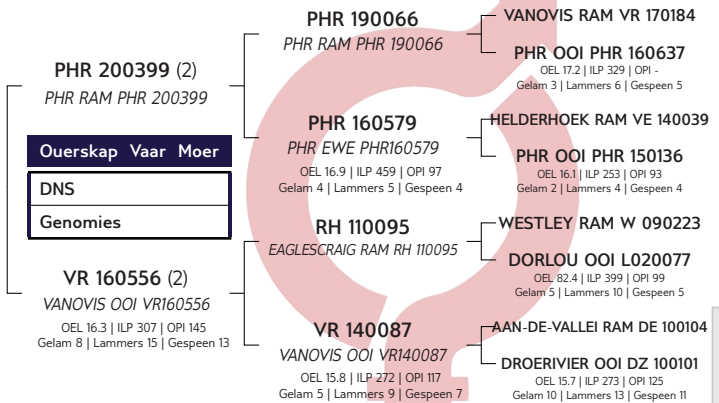

Groeï			Reproduksie			
Spn. Dir.	Spn. Mat.	Na-Spn.	GLS	TWW	OEL	ILP
104	95	101	86	86	100	100
61%	48%	41%	37%	37%	31%	25%

LOGIX
GENETICS / GENETIKA
EBV Analise 2024-02-02

Logix Meriete Indeks	97
Groeï Indeks	105
Reproduksie Indeks	88

VERKOPER OPMERKINGS:

LOT 18 (M)



UMPUKANE DORMERS

Clocolan, Free State
peet@umpukane.co.za

PHR 220126

PHR RAM PHR 220126



Kuddeboek	SP
Geb. dtm	2022-10-11
Oud.	1.4 jaar
Inteling	4.96%
Geb. Status	2
Nageslag	
Geen	

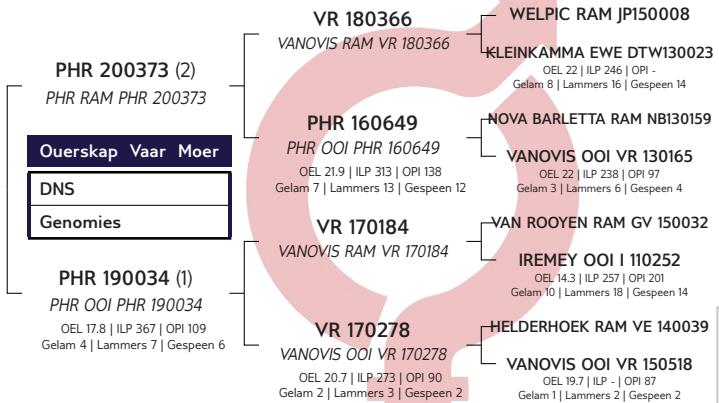

Groeï			Reproduksie			
Spn. Dir.	Spn. Mat.	Na-Spn.	GLS	TWW	OEL	ILP
117	90	116	100	100	109	100
61%	51%	38%	36%	36%	36%	22%

LOGIX
GENETICS / GENETIKA
EBV Analise 2024-02-02

Logix Meriete Indeks	116
Groeï Indeks	116
Reproduksie Indeks	104

VERKOPER OPMERKINGS:



LOT 19 (M)



UMPUKANE DORMERS
Clocolan, Free State
peet@umpukane.co.za

PHR 220134

PHR RAM PHR 220134



Herd Book	SP
Birth date	2022-10-14
Age	1.4 years
Inbreeding	5.34%
Birth Stat.	2
Progeny	None

PHR 200399 (2) PHR RAM PHR 200399
Parentage Sire Dam
DNA
Genomic
VR 150415 (1) VANOVIS OOI VR 150415 AFL 20.6 ILP 324 EPI 130 Lambded 8 Lambs 12 Weaned 10

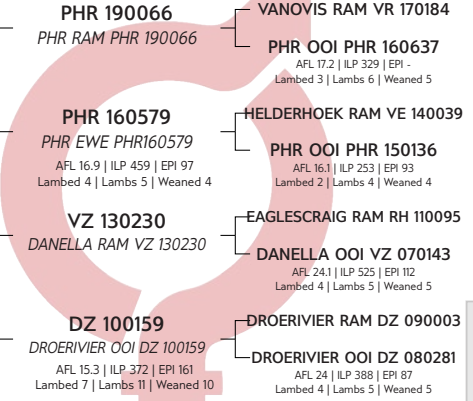

Growth			Reproduction			
Wn. Dir.	Wean Mat.	Post-Wn.	NLW	TWW	AFL	ILP
107	91	102	88	88	100	98
59%	45%	37%	32%	32%	25%	19%

LOGIX
GENETICS / GENETIKA
EBV Analysis 2024-02-02

Logix Merit Index	99
Growth Index	106
Reproduction Index	87

SELLER REMARKS:

LOT 20 (M)



UMPUKANE DORMERS
Clocolan, Free State
peet@umpukane.co.za

PHR 220138

PHR RAM PHR 220138



Herd Book	SP
Birth date	2022-10-15
Age	1.4 years
Inbreeding	7.54%
Birth Stat.	2
Progeny	None

PHR 200411 (3) PHR RAM PHR 200411
Parentage Sire Dam
DNA
Genomic
PHR 170348 (2) PHR OOI PHR 170348 AFL 16.7 ILP 321 EPI 107 Lambded 5 Lambs 8 Weaned 7

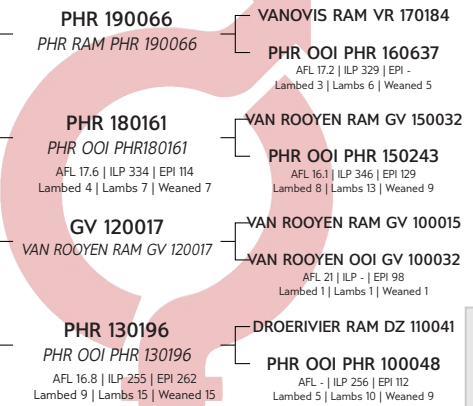

Growth			Reproduction			
Wn. Dir.	Wean Mat.	Post-Wn.	NLW	TWW	AFL	ILP
97	96	95	87	87	103	104
60%	47%	44%	34%	34%	29%	22%

LOGIX
GENETICS / GENETIKA
EBV Analysis 2024-02-02

Logix Merit Index	93
Growth Index	98
Reproduction Index	90

SELLER REMARKS:

LOT 21 (M)



NOVA BARLETTA BOERDERY
Clocolan, Free State
0725976047
novabarletta@gmail.com

NB 220021

NOVA BARLETTA RAM NB220021



Herd Book	SP
Birth date	2022-03-13
Age	1.9 years
Inbreeding	6.63%
Birth Stat.	2
Progeny	None

NB 200104 (3) NOVA BARLETTA ARMSTRONG
Parentage Sire Dam
DNA
Genomic
NB 170049 (2) NOVA BARLETTA EWE NB170049 AFL 18.3 ILP 344 EPI 131 Lambded 6 Lambs 11 Weaned 10

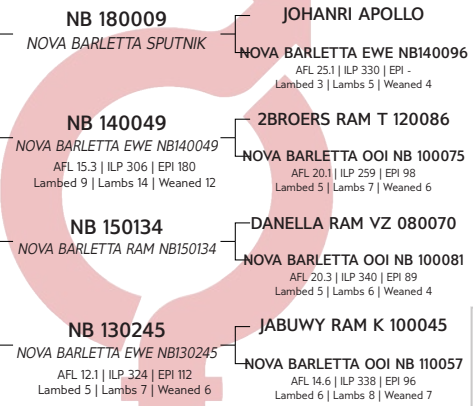

Growth			Reproduction			
Wn. Dir.	Wean Mat.	Post-Wn.	NLW	TWW	AFL	ILP
105	93	104	109	109	104	104
63%	53%	41%	41%	41%	38%	28%

LOGIX
GENETICS / GENETIKA
EBV Analysis 2024-02-02

Logix Merit Index	111
Growth Index	105
Reproduction Index	110

SELLER REMARKS:

LOT 22 (M)



NOVA BARLETTA BOERDERY

Clocolan, Free State
0725976047
novabarletta@gmail.com

NB 220072

NOVA BARLETTA RAM NB220072



Kuddeboek	SP
Geb. dtm	2022-03-14
Oud.	1.9 jaar
Inteling	6.29%
Geb. Status	2
Nageslag	
Geen	

NB 180463 (3)
NOVA BARLETTA RECYCLE

Uerskap Vaar Moer
DNS
Genomies

NB 180445 (3)
NOVA BARLETTA EWE NB180445
OEL 20.3 | ILP 359 | OPI 127
Gelam 4 | Lammers 8 | Gespeen 8

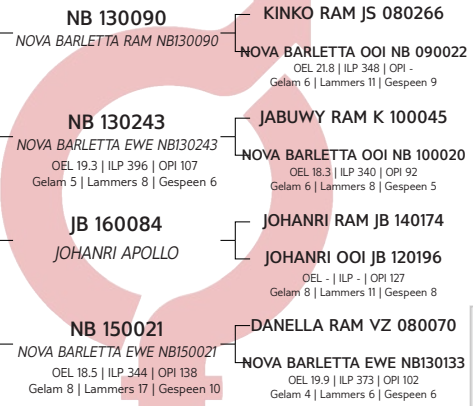

Groeï			Reproduksie			
Spn. Dir.	Spn. Mat.	Na-Spn.	GLS	TWW	OEL	ILP
99	105	94	96	96	98	104
64%	54%	56%	43%	43%	41%	33%



EBV Analise 2024-02-02

Logix Meriete Indeks	102
Groeï Indeks	104
Reproduksie Indeks	102

VERKOPER OPMERKINGS: VOV 4 GDT 475

LOT 23 (M)



NOVA BARLETTA BOERDERY

Clocolan, Free State
0725976047
novabarletta@gmail.com

NB 220300

NOVA BARLETTA RAM NB220300



Kuddeboek	SP
Geb. dtm	2022-03-17
Oud.	1.9 jaar
Inteling	5.34%
Geb. Status	1
Nageslag	
Geen	

JT 160062 (2)
REMKUIL RAM JT 160062

Uerskap Vaar Moer
DNS
Genomies

NB 180452 (3)
NOVA BARLETTA EWE NB180452
OEL 20.3 | ILP 360 | OPI 95
Gelam 3 | Lammers 5 | Gespeen 4

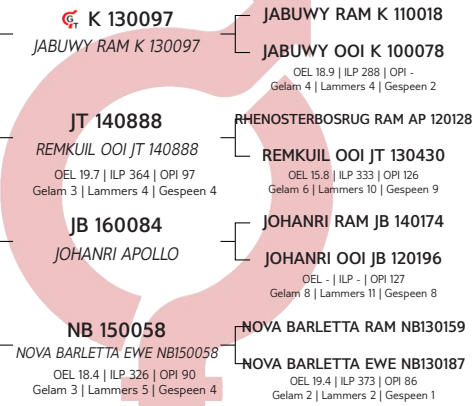

Groeï			Reproduksie			
Spn. Dir.	Spn. Mat.	Na-Spn.	GLS	TWW	OEL	ILP
112	93	118	102	102	89	97
63%	58%	56%	50%	50%	49%	40%



EBV Analise 2024-02-02

Logix Meriete Indeks	108
Groeï Indeks	112
Reproduksie Indeks	98

VERKOPER OPMERKINGS:

LOT 24 (M)



NOVA BARLETTA BOERDERY

Clocolan, Free State
0725976047
novabarletta@gmail.com

NB 220100

NOVA BARLETTA RAM NB220100



Kuddeboek	SP
Geb. dtm	2022-03-14
Oud.	1.9 jaar
Inteling	4.6%
Geb. Status	2
Nageslag	
Geen	

JS 180231 (1)
KINKO RAM JS 180231

Uerskap Vaar Moer
DNS
Genomies

NB 200367 (1)
NOVA BARLETTA EWE NB200367
OEL 22.5 | ILP - | OPI 94
Gelam 1 | Lammers 2 | Gespeen 2

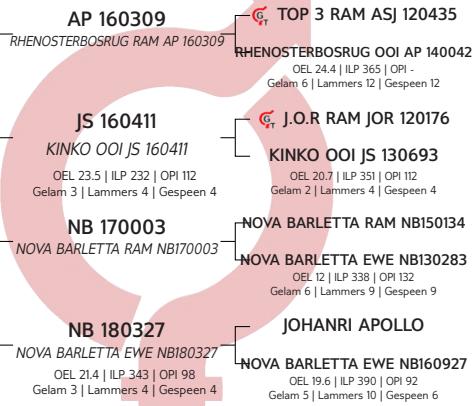

Groeï			Reproduksie			
Spn. Dir.	Spn. Mat.	Na-Spn.	GLS	TWW	OEL	ILP
111	85	110	109	109	98	105
61%	54%	49%	42%	42%	43%	28%



EBV Analise 2024-02-02

Logix Meriete Indeks	111
Groeï Indeks	107
Reproduksie Indeks	103

VERKOPER OPMERKINGS:

LOT 25 (M)



NOVA BARLETTA BOERDERY



Clocolan, Free State

0725976047

novabarletta@gmail.com

NB 220107

NOVA BARLETTA RAM NB220107



Herd Book	SP
Birth date	2022-03-15
Age	1.9 years
Inbreeding	12.9%
Birth Stat.	2
Progeny	None

NB 180463 (3)
NOVA BARLETTA RECYCLE

Parentage Sire Dam
DNA
Genomic

NB 190557 (1)
NOVA BARLETTA EWE NB190557
AFL 21.6 | ILP 298 | EPI 93
Lambd 2 | Lams 3 | Weaned 3

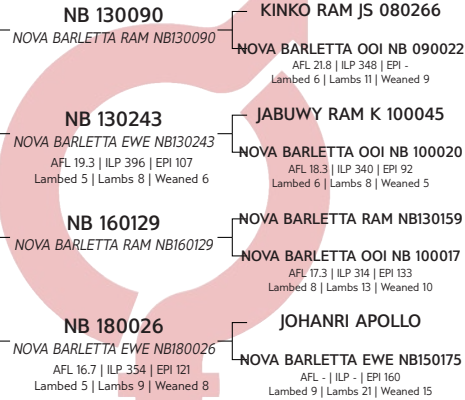

Growth			Reproduction			
Wn. Dir.	Wean Mat.	Post-Wn.	NLW	TWW	AFL	ILP
92	105	83	92	92	101	112
62%	51%	46%	39%	39%	38%	29%



EBV Analysis 2024-02-02

Logix Merit Index	95
Growth Index	98
Reproduction Index	99

SELLER REMARKS:

LOT 26 (M)



UMPUKANE DORMERS



Clocolan, Free State

peet@umpukane.co.za

PHR 220166

PHR RAM PHR 220166



Herd Book	SP
Birth date	2022-10-25
Age	1.3 years
Inbreeding	8.88%
Birth Stat.	2
Progeny	None

PHR 200381 (1)
PHR RAM PHR 200381

Parentage Sire Dam
DNA
Genomic

PHR 210026 (2)
PHR OOI PHR 210026
AFL 19 | ILP 346 | EPI 91
Lambd 2 | Lams 3 | Weaned 1

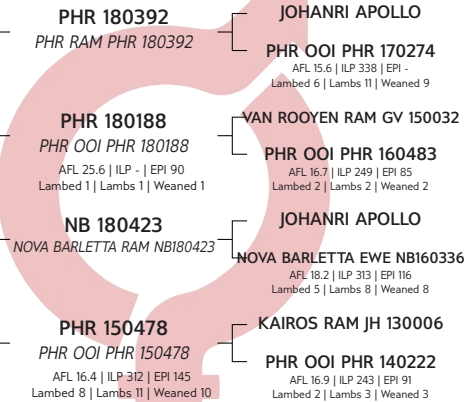

Growth			Reproduction			
Wn. Dir.	Wean Mat.	Post-Wn.	NLW	TWW	AFL	ILP
95	110	94	78	78	94	115
53%	38%	29%	29%	29%	28%	21%



EBV Analysis 2024-02-02

Logix Merit Index	92
Growth Index	104
Reproduction Index	89

SELLER REMARKS:

LOT 27 (M)



UMPUKANE DORMERS



Clocolan, Free State

peet@umpukane.co.za

PHR 220173

PHR RAM PHR 220173



Herd Book	SP
Birth date	2022-10-29
Age	1.3 years
Inbreeding	6.77%
Birth Stat.	2
Progeny	None

PHR 200373 (2)
PHR RAM PHR 200373

Parentage Sire Dam
DNA
Genomic

PHR 200400 (2)
PHR OOI PHR 200400
AFL 25 | ILP - | EPI 95
Lambd 1 | Lams 2 | Weaned 2

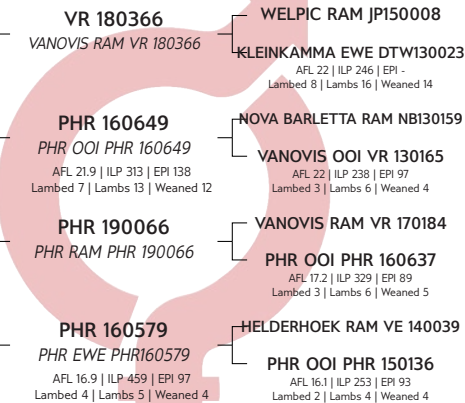

Growth			Reproduction			
Wn. Dir.	Wean Mat.	Post-Wn.	NLW	TWW	AFL	ILP
113	86	112	105	105	108	92
60%	48%	39%	33%	33%	35%	20%



EBV Analysis 2024-02-02

Logix Merit Index	112
Growth Index	110
Reproduction Index	103

SELLER REMARKS:

LOT 28 (M)

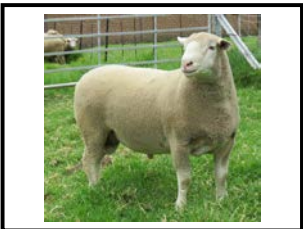

PHR 220195

PHR RAM PHR 220195



Kuddeboek	SP
Geb. dtm	2022-11-06
Oud.	1.3 jaar
Inteling	5.57%
Geb. Status	2
Nageslag	
Geen	

PHR 200373 (2)
PHR RAM PHR 200373

Ouerskap Vaar Moer
DNS
Genomies

PHR 190010 (2)
PHR OOI PHR 190010
OEL 17.5 | ILP 387 | OPI 100
Gelam 3 | Lammers 4 | Gespeen 4

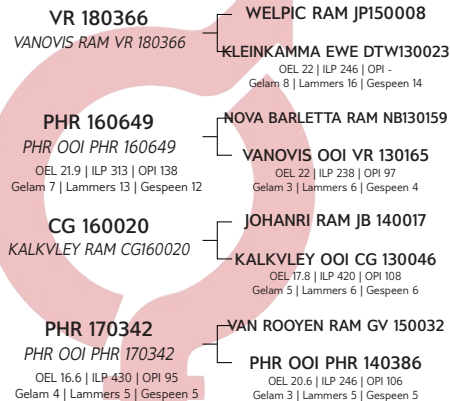

Groeï			Reproduksie			
Spn. Dir.	Spn. Mat.	Na-Spn.	GLS	TWW	OEL	ILP
113	94	115	86	86	106	95
61%	51%	38%	37%	37%	37%	24%



EBV Analise 2024-02-02

Logix Meriete Indeks	106
Groeï Indeks	114
Reproduksie Indeks	91

VERKOPER OPMERKINGS:

LOT 29 (M)



PHR 220115

PHR RAM PHR 220115



Kuddeboek	SP
Geb. dtm	2022-10-07
Oud.	1.4 jaar
Inteling	12.56%
Geb. Status	2
Nageslag	
Geen	

PHR 200373 (2)
PHR RAM PHR 200373

Ouerskap Vaar Moer
DNS
Genomies

VR 180357 (2)
VANOVIS OOI VR 180357
OEL 22.7 | ILP 370 | OPI 142
Gelam 4 | Lammers 7 | Gespeen 7

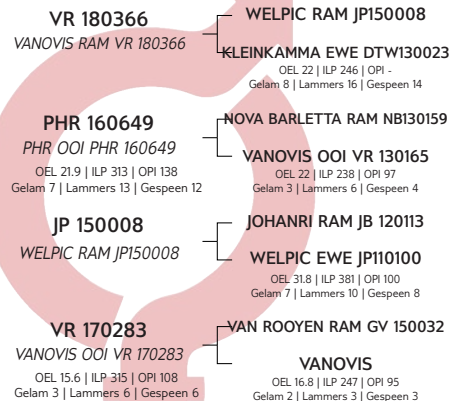

Groeï			Reproduksie			
Spn. Dir.	Spn. Mat.	Na-Spn.	GLS	TWW	OEL	ILP
115	89	116	95	95	113	99
61%	52%	38%	36%	36%	36%	23%



EBV Analise 2024-02-02

Logix Meriete Indeks	112
Groeï Indeks	113
Reproduksie Indeks	99

VERKOPER OPMERKINGS:

LOT 30 (M)



PHR 220129

PHR RAM PHR 220129



Kuddeboek	SP
Geb. dtm	2022-10-12
Oud.	1.4 jaar
Inteling	5.33%
Geb. Status	2
Nageslag	
Geen	

NB 200097 (2)
NOVA BARLETTA RAM NB200097

Ouerskap Vaar Moer
DNS
Genomies

PHR 190021 (2)
PHR OOI PHR 190021
OEL 17.4 | ILP 376 | OPI 104
Gelam 3 | Lammers 6 | Gespeen 6

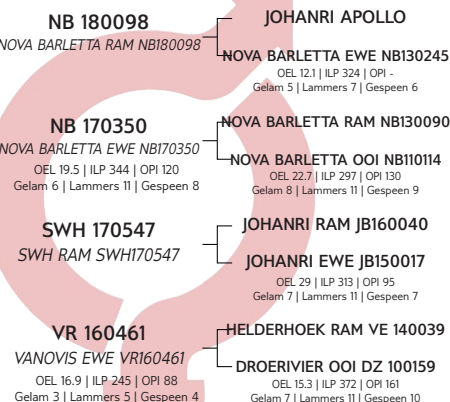

Groeï			Reproduksie			
Spn. Dir.	Spn. Mat.	Na-Spn.	GLS	TWW	OEL	ILP
105	97	99	89	89	96	96
57%	43%	32%	31%	31%	28%	23%



EBV Analise 2024-02-02

Logix Meriete Indeks	99
Groeï Indeks	106
Reproduksie Indeks	91

VERKOPER OPMERKINGS:

LOT 31 (M)



NOVA BARLETTA BOERDERY

Clocolan, Free State
0725976047
novabarletta@gmail.com

NB 220220

NOVA BARLETTA RAM NB220220



Herd Book	SP
Birth date	2022-03-16
Age	1.9 years
Inbreeding	4.93%
Birth Stat.	2
Progeny	None

♂ **JT 160062 (2)**
REMKUIL RAM JT 160062

Parentage Sire Dam
DNA
Genomic

NB 180775 (2)
NOVA BARLETTA EWE NB180775
AFL 18.8 | ILP 348 | EPI 114
Lambded 4 | Lambs 7 | Weaned 7

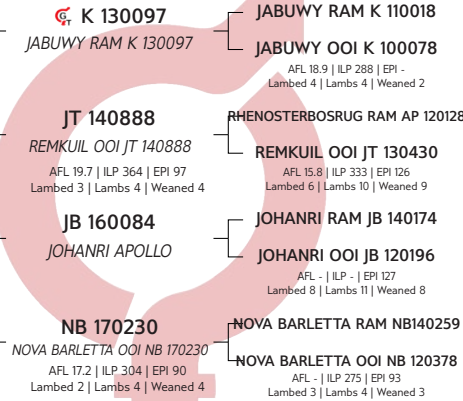

Growth			Reproduction			
Wn. Dir.	Wean Mat.	Post-Wn.	NLW	TWW	AFL	ILP
106	93	113	105	105	84	93
64%	59%	47%	50%	50%	49%	39%



EBV Analysis 2024-02-02

Logix Merit Index	104
Growth Index	106
Reproduction Index	98

SELLER REMARKS:

LOT 32 (M)



NOVA BARLETTA BOERDERY

Clocolan, Free State
0725976047
novabarletta@gmail.com

NB 220192

NOVA BARLETTA RAM NB220192



Herd Book	SP
Birth date	2022-03-15
Age	1.9 years
Inbreeding	4.66%
Birth Stat.	2
Progeny	None

♂ **JS 180231 (1)**
KINKO RAM JS 180231

Parentage Sire Dam
DNA
Genomic

NB 200262 (2)
NOVA BARLETTA EWE NB200262
AFL 22.6 | ILP - | EPI 95
Lambded 1 | Lambs 2 | Weaned 2

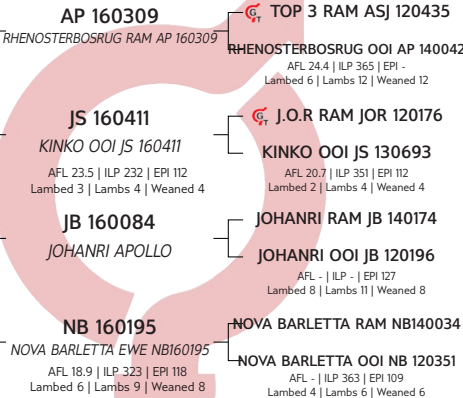

Growth			Reproduction			
Wn. Dir.	Wean Mat.	Post-Wn.	NLW	TWW	AFL	ILP
110	92	109	101	101	103	94
62%	55%	58%	45%	45%	46%	32%



EBV Analysis 2024-02-02

Logix Merit Index	108
Growth Index	109
Reproduction Index	101

SELLER REMARKS:

LOT 33 (M)



NOVA BARLETTA BOERDERY

Clocolan, Free State
0725976047
novabarletta@gmail.com

NB 220101

NOVA BARLETTA RAM NB220101



Herd Book	SP
Birth date	2022-03-14
Age	1.9 years
Inbreeding	4.6%
Birth Stat.	2
Progeny	None

♂ **JS 180231 (1)**
KINKO RAM JS 180231

Parentage Sire Dam
DNA
Genomic

NB 200367 (1)
NOVA BARLETTA EWE NB200367
AFL 22.5 | ILP - | EPI 94
Lambded 1 | Lambs 2 | Weaned 2

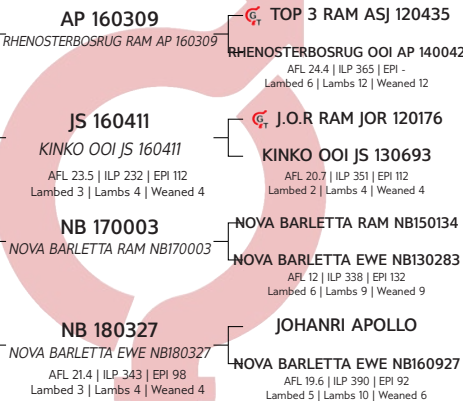

Growth			Reproduction			
Wn. Dir.	Wean Mat.	Post-Wn.	NLW	TWW	AFL	ILP
111	85	110	109	109	98	105
61%	54%	49%	42%	42%	43%	28%



EBV Analysis 2024-02-02

Logix Merit Index	111
Growth Index	107
Reproduction Index	103

SELLER REMARKS:

LOT 34 (M)



NOVA BARLETTA BOERDERY

Clocolan, Free State
0725976047
novabarletta@gmail.com

NB 220217

NOVA BARLETTA RAM NB220217



Kuddeboek	SP
Geb. dtm	2022-03-16
Oud.	1.9 jaar
Inteling	11.53%
Geb. Status	2
Nageslag	
Geen	

NB 180463 (3)
NOVA BARLETTA RECYCLE

Ouerskap Vaar Moer
DNS
Genomies

NB 180606 (2)
NOVA BARLETTA EWE NB180606
OEL 20.1 | ILP 360 | OPI 121
Gelam 4 | Lammers 8 | Gespeen 7

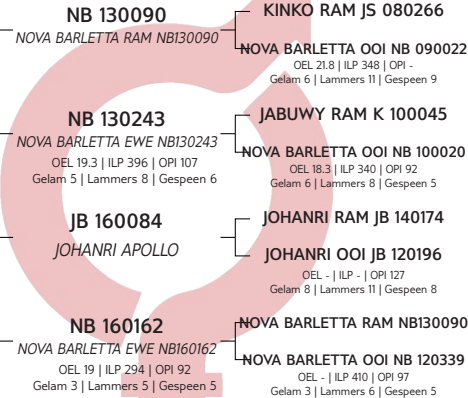

Groeï			Reproduksie			
Spn. Dir.	Spn. Mat.	Na-Spn.	GLS	TWW	OEL	ILP
99	107	91	92	92	99	107
64%	54%	56%	42%	42%	41%	32%



EBV Analise 2024-02-02

Logix Meriete Indeks	101
Groeï Indeks	105
Reproduksie Indeks	101

VERKOPER OPMERKINGS:

LOT 35 (M)



NOVA BARLETTA BOERDERY

Clocolan, Free State
0725976047
novabarletta@gmail.com

NB 220066

NOVA BARLETTA RAM NB220066



Kuddeboek	SP
Geb. dtm	2022-03-14
Oud.	1.9 jaar
Inteling	15.47%
Geb. Status	2
Nageslag	
Geen	

NB 180463 (3)
NOVA BARLETTA RECYCLE

Ouerskap Vaar Moer
DNS
Genomies

NB 190695 (1)
NOVA BARLETTA EWE NB190695
OEL 19.7 | ILP 331 | OPI 105
Gelam 3 | Lammers 6 | Gespeen 5

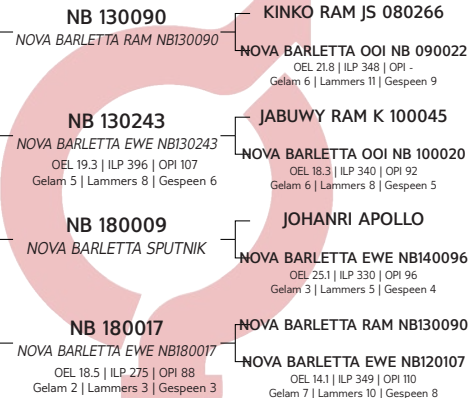

Groeï			Reproduksie			
Spn. Dir.	Spn. Mat.	Na-Spn.	GLS	TWW	OEL	ILP
104	96	94	90	90	104	108
63%	52%	48%	40%	40%	39%	30%



EBV Analise 2024-02-02

Logix Meriete Indeks	102
Groeï Indeks	106
Reproduksie Indeks	95

VERKOPER OPMERKINGS:

LOT 36 (M)



UMPUKANE DORMERS

Clocolan, Free State
peet@umpukane.co.za

PHR 220154

PHR RAM PHR 220154



Kuddeboek	SP
Geb. dtm	2022-10-22
Oud.	1.3 jaar
Inteling	5.11%
Geb. Status	2
Nageslag	
Geen	

PHR 200373 (2)
PHR RAM PHR 200373

Ouerskap Vaar Moer
DNS
Genomies

PHR 190099 (2)
PHR OOI PHR 190099
OEL 16.9 | ILP 378 | OPI 99
Gelam 3 | Lammers 5 | Gespeen 5

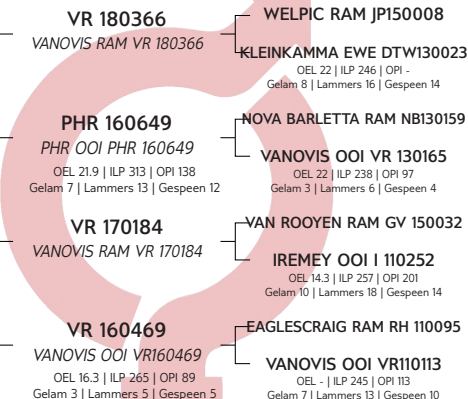

Groeï			Reproduksie			
Spn. Dir.	Spn. Mat.	Na-Spn.	GLS	TWW	OEL	ILP
109	89	110	103	103	112	95
61%	51%	38%	36%	36%	36%	23%



EBV Analise 2024-02-02

Logix Meriete Indeks	110
Groeï Indeks	107
Reproduksie Indeks	104

VERKOPER OPMERKINGS:



LOT 37 (M)



UMPUKANE DORMERS
Clocolan, Free State
peet@umpukane.co.za



PHR 220147

PHR RAM PHR 220147

Herd Book	SP
Birth date	2022-10-19
Age	1.4 years
Inbreeding	4.44%
Birth Stat.	1
Progeny	None

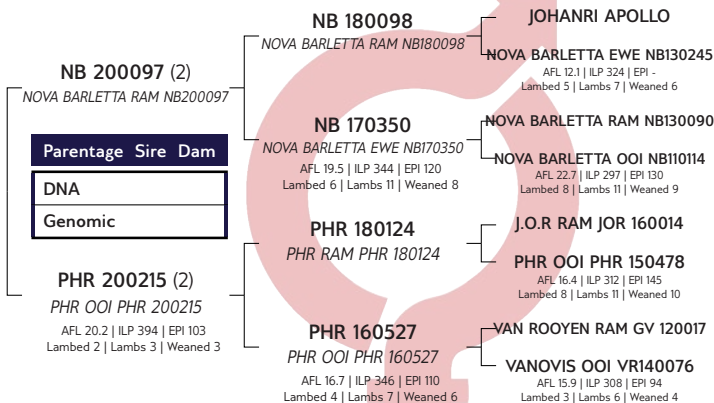

Growth			Reproduction			
Wn. Dir.	Wean Mat.	Post-Wn.	NLW	TWW	AFL	ILP
101	100	97	86	86	98	107
55%	40%	31%	29%	29%	26%	22%



EBV Analysis 2024-02-02

Logix Merit Index	97
Growth Index	105
Reproduction Index	91

SELLER REMARKS:

LOT 38 (M)



UMPUKANE DORMERS
Clocolan, Free State
peet@umpukane.co.za



PHR 220214

PHR RAM PHR 220214

Herd Book	SP
Birth date	2022-11-10
Age	1.3 years
Inbreeding	5.58%
Birth Stat.	2
Progeny	None

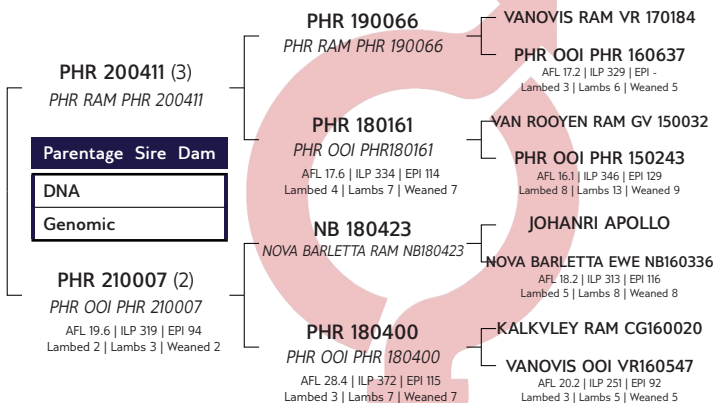

Growth			Reproduction			
Wn. Dir.	Wean Mat.	Post-Wn.	NLW	TWW	AFL	ILP
98	103	99	93	93	95	105
58%	42%	39%	29%	29%	28%	20%



EBV Analysis 2024-02-02

Logix Merit Index	98
Growth Index	102
Reproduction Index	97

SELLER REMARKS:

LOT 39 (M)



UMPUKANE DORMERS
Clocolan, Free State
peet@umpukane.co.za



PHR 220133

PHR RAM PHR 220133

Herd Book	SP
Birth date	2022-10-13
Age	1.4 years
Inbreeding	5.48%
Birth Stat.	2
Progeny	None

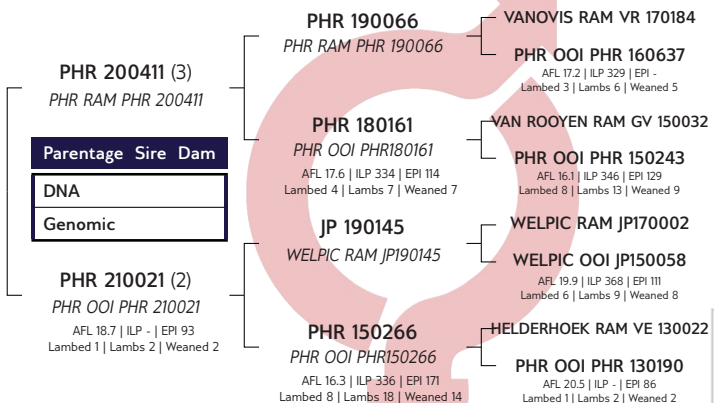

Growth			Reproduction			
Wn. Dir.	Wean Mat.	Post-Wn.	NLW	TWW	AFL	ILP
95	91	94	101	101	102	104
58%	41%	37%	28%	28%	25%	18%



EBV Analysis 2024-02-02

Logix Merit Index	96
Growth Index	94
Reproduction Index	98

SELLER REMARKS:



LOT 40 (M)



UMPUKANE DORMERS

Clocolan, Free State
peet@umpukane.co.za

PHR 22019

PHR RAM PHR 220119



Kuddeboek	SP
Geb. dtm	2022-10-08
Oud.	1.4 jaar
Inteling	4.74%
Geb. Status	2
Nageslag	
Geen	

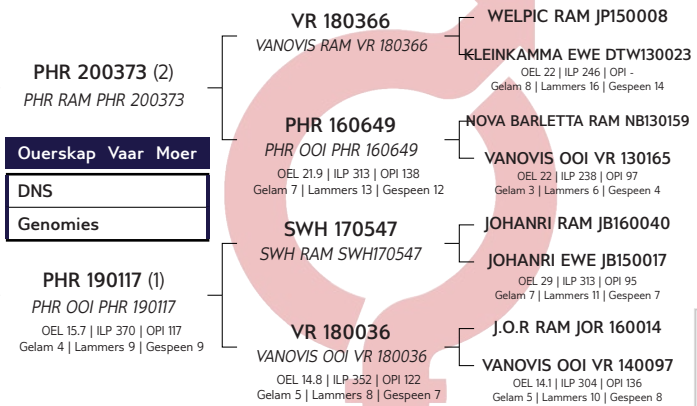

Groeï			Reproduksie			
Spn. Dir.	Spn. Mat.	Na-Spn.	GLS	TWW	OEL	ILP
120	84	119	108	108	106	100
61%	52%	38%	37%	37%	35%	22%



EBV Analise 2024-02-02

Logix Meriete Indeks	119
Groeï Indeks	115
Reproduksie Indeks	106

VERKOPER OPMERKINGS:

LOT 41 (M)



NOVA BARLETTA BOERDERY

Clocolan, Free State
0725976047
novabarletta@gmail.com

NB 220191

NOVA BARLETTA RAM NB220191



Kuddeboek	SP
Geb. dtm	2022-03-15
Oud.	1.9 jaar
Inteling	15.33%
Geb. Status	2
Nageslag	
Geen	

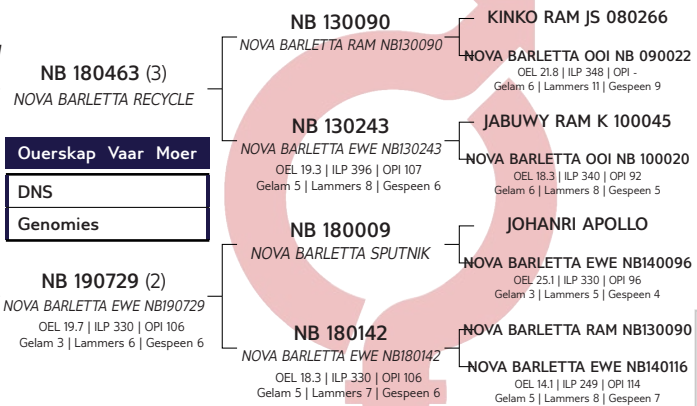

Groeï			Reproduksie			
Spn. Dir.	Spn. Mat.	Na-Spn.	GLS	TWW	OEL	ILP
101	92	92	96	96	103	112
63%	53%	48%	41%	41%	39%	30%



EBV Analise 2024-02-02

Logix Meriete Indeks	100
Groeï Indeks	100
Reproduksie Indeks	96

VERKOPER OPMERKINGS:

LOT 42 (M)



NOVA BARLETTA BOERDERY

Clocolan, Free State
0725976047
novabarletta@gmail.com

NB 220173

NOVA BARLETTA RAM NB220173



Kuddeboek	SP
Geb. dtm	2022-03-15
Oud.	1.9 jaar
Inteling	4.22%
Geb. Status	2
Nageslag	
Geen	

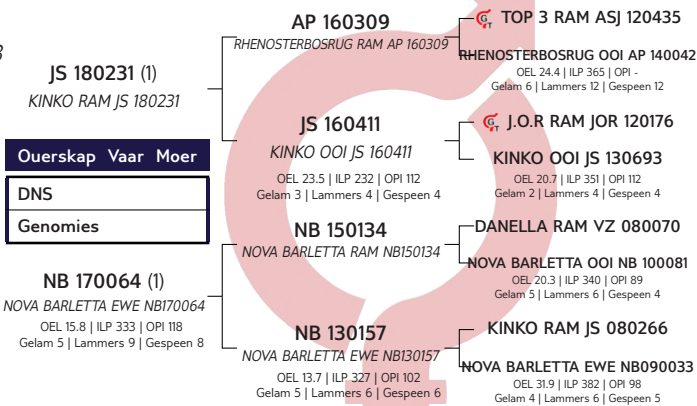

Groeï			Reproduksie			
Spn. Dir.	Spn. Mat.	Na-Spn.	GLS	TWW	OEL	ILP
112	95	109	107	107	107	103
63%	57%	57%	45%	45%	44%	30%



EBV Analise 2024-02-02

Logix Meriete Indeks	116
Groeï Indeks	112
Reproduksie Indeks	111

VERKOPER OPMERKINGS:

LOT 43 (F)



NOVA BARLETTA BOERDERY

Clocolan, Free State
0725976047
novabarletta@gmail.com

NB 210310

NOVA BARLETTA EWE NB210310



Herd Book	SP	
Birth date	2021-04-08	
Age	2.9 years	
Inbreeding	5.02%	
Birth Stat.	2	
AFL	ILP	EPI
23m	-	99
Lambled	1	
Lambs	1	
Weaned	1	

NB 180009 (2)
NOVA BARLETTA SPUTNIK

Parentage	Sire	Dam
DNA		
Genomic		

NB 190143 (2)
NOVA BARLETTA EWE NB190143
AFL 23.1 | ILP 403 | EPI 111
Lambled 3 | Lambs 5 | Weaned 5

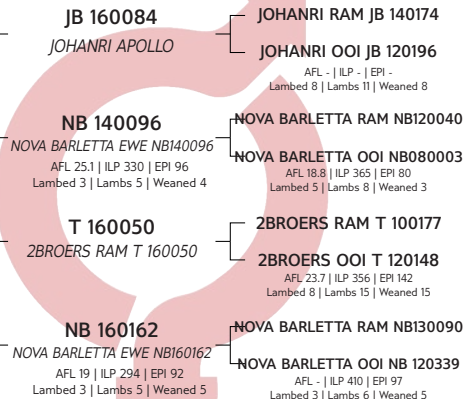

Growth			Reproduction			
Wn. Dir.	Wean Mat.	Post-Wn.	NLW	TWW	AFL	ILP
111	100	105	92	92	113	100
65%	62%	52%	51%	51%	51%	38%



EBV Analysis 2024-02-02

Logix Merit Index	112
Growth Index	114
Reproduction Index	103

SELLER REMARKS: Dragtig met tweeling van HE22-62 Lam 24 Maart

LOT 44 (F)



NOVA BARLETTA BOERDERY

Clocolan, Free State
0725976047
novabarletta@gmail.com

NB 200245

NOVA BARLETTA EWE NB200245



Herd Book	SP	
Birth date	2020-04-26	
Age	3.8 years	
Inbreeding	5.75%	
Birth Stat.	2	
AFL	ILP	EPI
14.4m	335d	112
Lambled	3	
Lambs	4	
Weaned	4	

NB 180009 (2)
NOVA BARLETTA SPUTNIK

Parentage	Sire	Dam
DNA		
Genomic		

NB 160875 (3)
NOVA BARLETTA EWE NB160875
AFL 20 | ILP 333 | EPI 110
Lambled 5 | Lambs 8 | Weaned 8

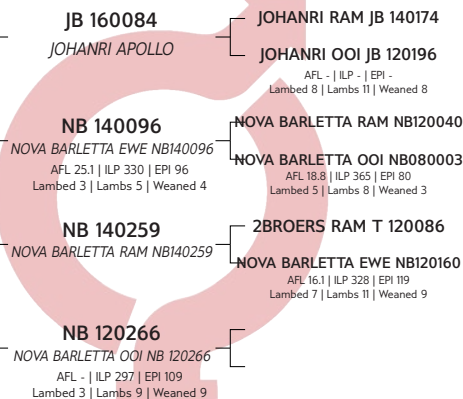

Growth			Reproduction			
Wn. Dir.	Wean Mat.	Post-Wn.	NLW	TWW	AFL	ILP
113	102	109	91	91	121	96
67%	69%	49%	53%	53%	49%	39%



EBV Analysis 2024-02-02

Logix Merit Index	114
Growth Index	117
Reproduction Index	106

SELLER REMARKS: Dragtig met drieling van T22-332 Lam 24 Maart

LOT 45 (F)



NOVA BARLETTA BOERDERY

Clocolan, Free State
0725976047
novabarletta@gmail.com

NB 210461

NOVA BARLETTA EWE NB210461



Herd Book	SP	
Birth date	2021-05-19	
Age	2.8 years	
Inbreeding	8.9%	
Birth Stat.	1	
AFL	ILP	EPI
21.6m	-	96
Lambled	1	
Lambs	2	
Weaned	1	

NB 190715 (2)
NOVA BARLETTA BUZZ

Parentage	Sire	Dam
DNA		
Genomic		

NB 180141 (3)
NOVA BARLETTA EWE NB180141
AFL 18.3 | ILP 330 | EPI 113
Lambled 5 | Lambs 7 | Weaned 7

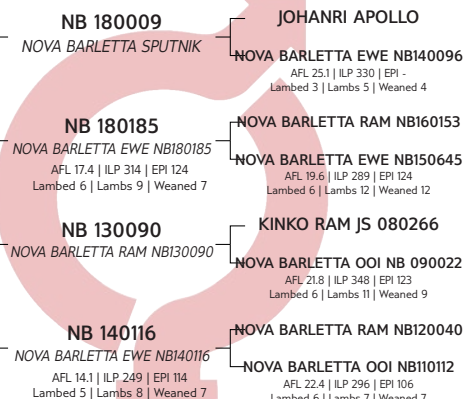

Growth			Reproduction			
Wn. Dir.	Wean Mat.	Post-Wn.	NLW	TWW	AFL	ILP
111	88	103	109	109	111	109
64%	59%	48%	46%	46%	47%	29%



EBV Analysis 2024-02-02

Logix Merit Index	115
Growth Index	108
Reproduction Index	110

SELLER REMARKS: Dragtig met tweeling van T22-332 Lam 24 Maart

LOT 46 (F)



NOVA BARLETTA BOERDERY

Clocolan, Free State
0725976047
novabarletta@gmail.com

NB 200347

NOVA BARLETTA EWE NB200347



Kuddeboek	SP	
Geb. dtm	2020-04-28	
Oud.	3.8 jaar	
Inteling	4.18%	
Geb. Status	2	
OEL	ILP	OPI
22.5m	358d	100
Gelam	2	
Lammers	3	
Gespeen	3	

JB 160084 (2)
JOHANRI APOLLO

Ouerskap Vaar Moer

DNS

Genomies

NB 150612 (1)
NOVA BARLETTA EWE NB150612
OEL 15 | ILP 328 | OPI 116
Gelam 7 | Lammers 11 | Gespeen 9

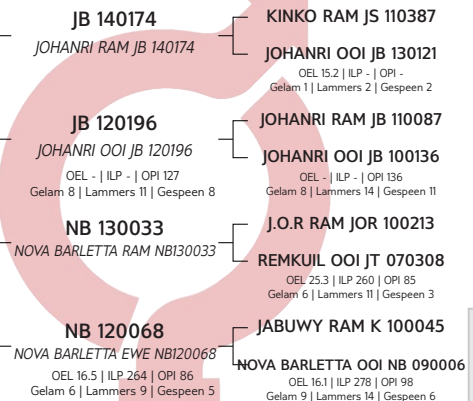

Groeï			Reproduksie			
Spn. Dir.	Spn. Mat.	Na-Spn.	GLS	TWW	OEL	ILP
96	106	94	97	97	98	99
67%	68%	56%	58%	58%	55%	49%



EBV Analise 2024-02-02

Logix Meriete Indeks	100
Groeï Indeks	102
Reproduksie Indeks	103

VERKOPER OPMERKINGS: Dragtig met drieling van HE22-62 Lam 24 Maart

LOT 47 (F)



NOVA BARLETTA BOERDERY

Clocolan, Free State
0725976047
novabarletta@gmail.com

NB 210214

NOVA BARLETTA EWE NB210214



Kuddeboek	SP	
Geb. dtm	2021-03-10	
Oud.	3 jaar	
Inteling	4.43%	
Geb. Status	3	
OEL	ILP	OPI
24m	-	95
Gelam	1	
Lammers	1	
Gespeen	1	

JB 160084 (2)
JOHANRI APOLLO

Ouerskap Vaar Moer

DNS

Genomies

NB 160133 (2)
NOVA BARLETTA EWE NB160133
OEL 19.3 | ILP 325 | OPI 149
Gelam 6 | Lammers 14 | Gespeen 14

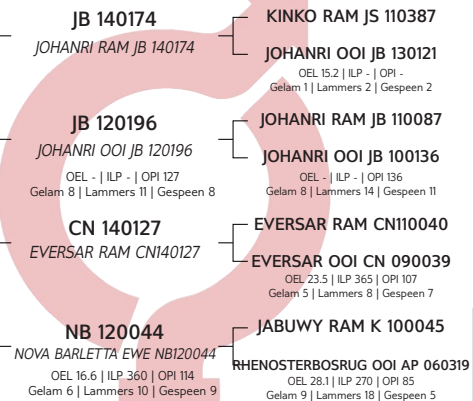

Groeï			Reproduksie			
Spn. Dir.	Spn. Mat.	Na-Spn.	GLS	TWW	OEL	ILP
94	103	94	101	101	100	106
66%	66%	57%	58%	58%	56%	47%



EBV Analise 2024-02-02

Logix Meriete Indeks	101
Groeï Indeks	99
Reproduksie Indeks	106

VERKOPER OPMERKINGS: Dragtig met tweeling van HE22-62 Lam 24 Maart

LOT 48 (F)



UMPUKANE DORMERS

Clocolan, Free State
peet@umpukane.co.za

PHR 210028

PHR OOI PHR 210028



Kuddeboek	SP	
Geb. dtm	2021-03-25	
Oud.	2.9 jaar	
Inteling	4.56%	
Geb. Status	2	
OEL	ILP	OPI
19.5m	-	97
Gelam	1	
Lammers	3	
Gespeen	3	

JP 190145 (1)
WELPIC RAM JP190145

Ouerskap Vaar Moer

DNS

Genomies

PHR 180429 (3)
PHR OOI PHR 180429
OEL 16.7 | ILP 362 | OPI 102
Gelam 3 | Lammers 5 | Gespeen 5

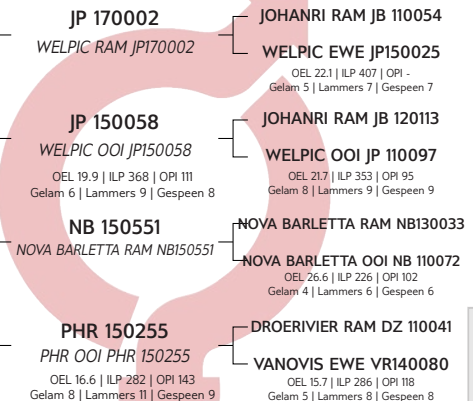

Groeï			Reproduksie			
Spn. Dir.	Spn. Mat.	Na-Spn.	GLS	TWW	OEL	ILP
97	90	94	119	119	106	109
62%	59%	28%	37%	37%	35%	24%



EBV Analise 2024-02-02

Logix Meriete Indeks	109
Groeï Indeks	95
Reproduksie Indeks	117

VERKOPER OPMERKINGS: Dragtig met tweeling van PHR220094 Lam vanaf 28 Maart

LOT 49 (F)



PHR 210148

PHR OOI PHR 210148

Herd Book	SP
Birth date	2021-09-21
Age	2.4 years
Inbreeding	4.93%
Birth Stat.	2

AFL	ILP	EPI
18.3m	-	99

Lambled	1
Lambs	1
Weaned	1

UMPUKANE DORMERS

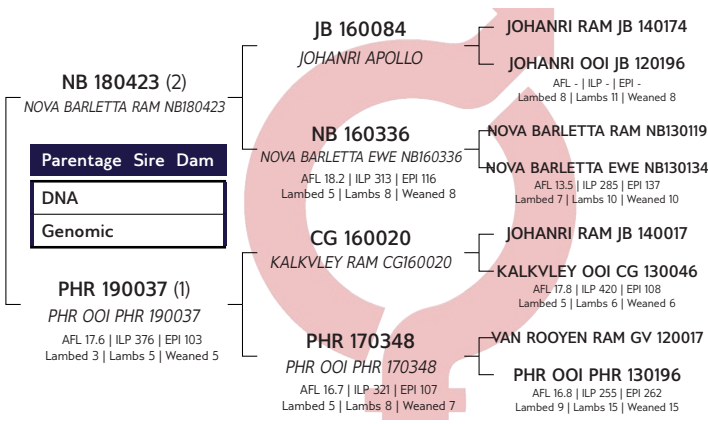
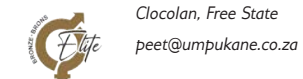

Growth			Reproduction			
Wn. Dir.	Wean Mat.	Post-Wn.	NLW	TWW	AFL	ILP
103	110	103	78	78	92	112
63%	58%	43%	44%	44%	45%	31%



EBV Analysis 2024-02-02

Logix Merit Index	98
Growth Index	111
Reproduction Index	90

SELLER REMARKS: Dragtig met eenling van PHR220008 Lam vanaf 28 Maart

LOT 50 (F)



PHR 210192

PHR OOI PHR 210192

Herd Book	SP
Birth date	2021-09-21
Age	2.4 years
Inbreeding	4.87%
Birth Stat.	2

AFL	ILP	EPI
18.6m	-	105

Lambled	1
Lambs	3
Weaned	2

UMPUKANE DORMERS

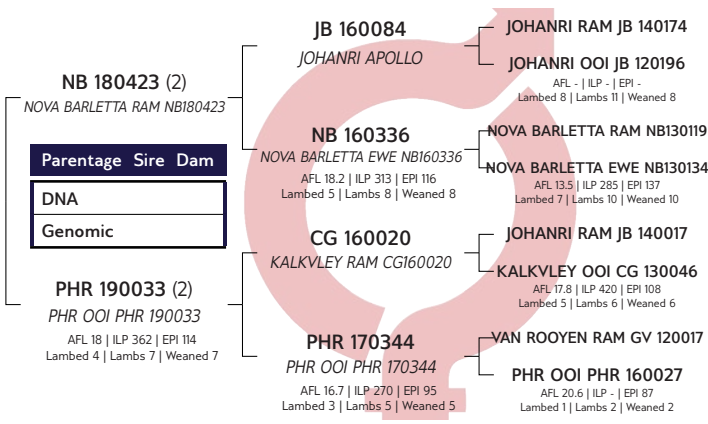
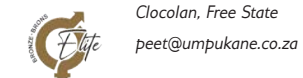

Growth			Reproduction			
Wn. Dir.	Wean Mat.	Post-Wn.	NLW	TWW	AFL	ILP
101	109	102	88	88	87	114
64%	62%	46%	45%	45%	45%	31%



EBV Analysis 2024-02-02

Logix Merit Index	100
Growth Index	108
Reproduction Index	95

SELLER REMARKS: Dragtig met tweeling van PHR220008 Lam vanaf 28 Maart

LOT 51 (F)



PHR 210225

PHR OOI PHR 210225

Herd Book	SP
Birth date	2021-10-02
Age	2.4 years
Inbreeding	6.34%
Birth Stat.	2

AFL	ILP	EPI
-	-	-

UMPUKANE DORMERS

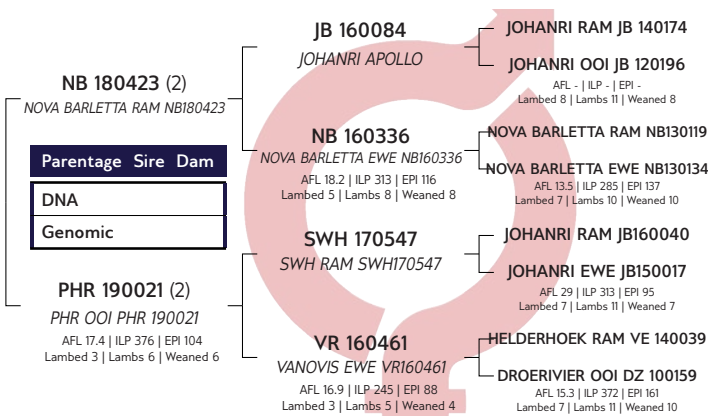
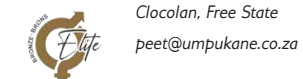

Growth			Reproduction			
Wn. Dir.	Wean Mat.	Post-Wn.	NLW	TWW	AFL	ILP
101	105	100	83	83	89	103
61%	53%	40%	41%	41%	39%	30%



EBV Analysis 2024-02-02

Logix Merit Index	95
Growth Index	107
Reproduction Index	88

SELLER REMARKS: Dragtig met eenling van PHR220008 Lam vanaf 28 Maart

LOT 52 (F)



UMPUKANE DORMERS
Clocolan, Free State
peet@umpukane.co.za

PHR 210154

PHR OOI PHR 210154

Kuddeboek	SP	
Geb. dtm	2021-09-21	
Oud.	2.4 jaar	
Inteling	6.63%	
Geb. Status	2	
OEL	ILP	OPI
18.9m	-	105
Gelam	1	
Lammers	2	
Gespeen	2	

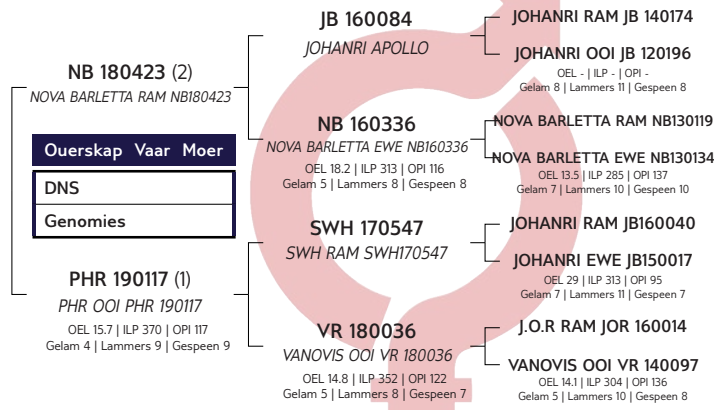

Groei			Reproduksie			
Spn. Dir.	Spn. Mat.	Na-Spn.	GLS	TWW	OEL	ILP
98	101	99	95	95	90	108
64%	62%	45%	44%	44%	43%	30%



EBV Analise 2024-02-02

Logix Meriete Indeks **98**

Groei Indeks **101**

Reproduksie Indeks **96**

VERKOPER OPMERKINGS: Dragtig met eenling van PHR220094 Lam vanaf 28 Maart

LOT 53 (F)



NOVA BARLETTA BOERDERY
Clocolan, Free State
0725976047
novabarletta@gmail.com

NB 200272

NOVA BARLETTA EWE NB200272

Kuddeboek	SP	
Geb. dtm	2020-04-27	
Oud.	3.8 jaar	
Inteling	9.36%	
Geb. Status	2	
OEL	ILP	OPI
22.5m	361d	101
Gelam	2	
Lammers	3	
Gespeen	3	

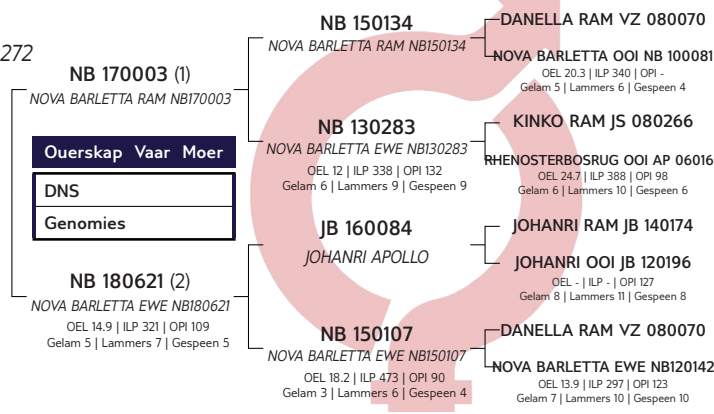

Groei			Reproduksie			
Spn. Dir.	Spn. Mat.	Na-Spn.	GLS	TWW	OEL	ILP
104	108	103	99	99	92	99
64%	64%	41%	48%	48%	45%	37%



EBV Analise 2024-02-02

Logix Meriete Indeks **108**

Groei Indeks **112**

Reproduksie Indeks **106**

VERKOPER OPMERKINGS: Dragtig met tweeling van T22-332 Lam 24 Maart

LOT 54 (F)



NOVA BARLETTA BOERDERY
Clocolan, Free State
0725976047
novabarletta@gmail.com

NB 200411

NOVA BARLETTA EWE NB200411

Kuddeboek	SP	
Geb. dtm	2020-04-30	
Oud.	3.8 jaar	
Inteling	5.75%	
Geb. Status	2	
OEL	ILP	OPI
14.2m	336d	112
Gelam	3	
Lammers	4	
Gespeen	4	

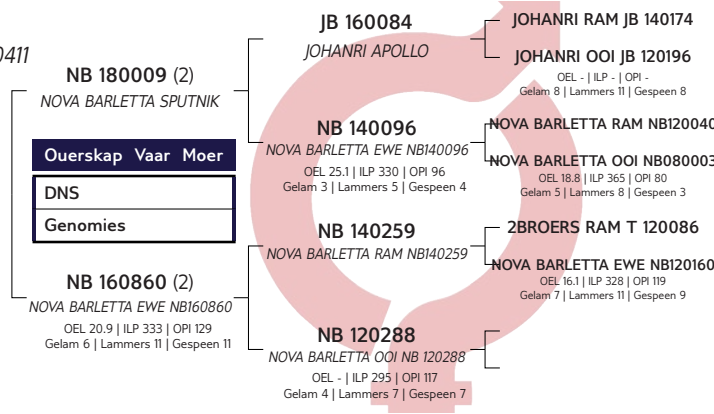

Groei			Reproduksie			
Spn. Dir.	Spn. Mat.	Na-Spn.	GLS	TWW	OEL	ILP
116	102	111	90	90	118	96
67%	69%	50%	54%	54%	48%	39%



EBV Analise 2024-02-02

Logix Meriete Indeks **115**

Groei Indeks **119**

Reproduksie Indeks **104**

VERKOPER OPMERKINGS: Dragtig met tweeling van T22-332 Lam 24 Maart

LOT 55 (F)



NB 210177

NOVA BARLETTA EWE NB210177

Herd Book	SP	
Birth date	2021-03-10	
Age	3 years	
Inbreeding	4.53%	
Birth Stat.	2	
AFL	ILP	EPI
17.3m	304d	107
Lambled	2	
Lambs	3	
Weaned	3	

NOVA BARLETTA BOERDERY

Clocolan, Free State

0725976047

novabarletta@gmail.com

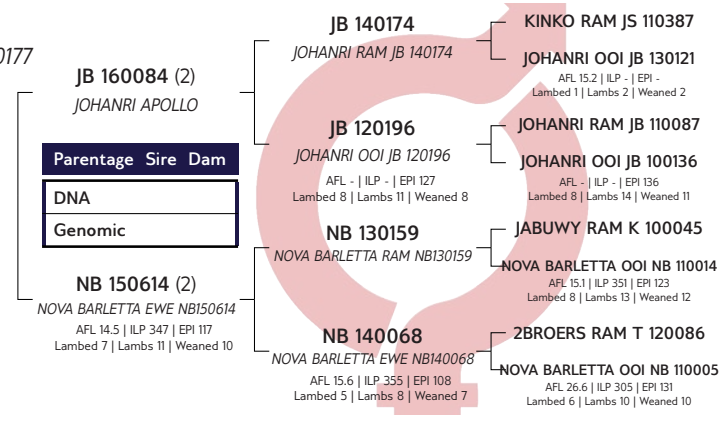

Growth			Reproduction			
Wn. Dir.	Wean Mat.	Post-Wn.	NLW	TWW	AFL	ILP
97	97	96	102	102	108	89
67%	69%	56%	58%	58%	55%	49%



EBV Analysis 2024-02-02

Logix Merit Index	101
Growth Index	99
Reproduction Index	104

SELLER REMARKS: Dragtig met tweeling van T22-332 Lam 24 Maart

LOT 56 (F)



NB 210318

NOVA BARLETTA EWE NB210318

Herd Book	SP	
Birth date	2021-04-09	
Age	2.9 years	
Inbreeding	6.02%	
Birth Stat.	2	
AFL	ILP	EPI
22.9m	-	103
Lambled	1	
Lambs	2	
Weaned	2	

NOVA BARLETTA BOERDERY

Clocolan, Free State

0725976047

novabarletta@gmail.com

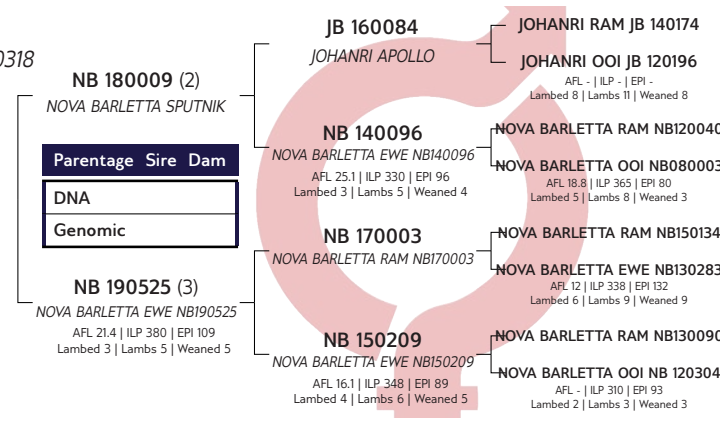

Growth			Reproduction			
Wn. Dir.	Wean Mat.	Post-Wn.	NLW	TWW	AFL	ILP
108	90	104	108	108	111	93
64%	64%	49%	49%	49%	48%	36%



EBV Analysis 2024-02-02

Logix Merit Index	112
Growth Index	106
Reproduction Index	108

SELLER REMARKS: Dragtig met tweeling van T22-332 Lam 24 Maart

LOT 57 (F)



NB 200124

NOVA BARLETTA EWE NB200124

Herd Book	SP	
Birth date	2020-03-27	
Age	3.9 years	
Inbreeding	4.49%	
Birth Stat.	2	
AFL	ILP	EPI
17.4m	324d	103
Lambled	3	
Lambs	4	
Weaned	3	

NOVA BARLETTA BOERDERY

Clocolan, Free State

0725976047

novabarletta@gmail.com

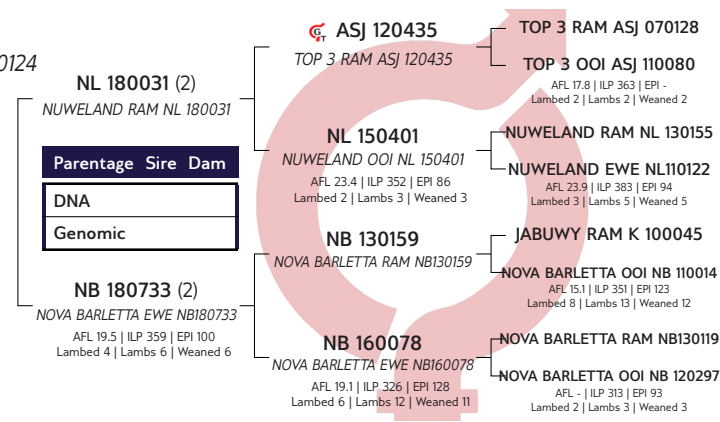

Growth			Reproduction			
Wn. Dir.	Wean Mat.	Post-Wn.	NLW	TWW	AFL	ILP
102	112	101	92	92	91	112
64%	64%	44%	49%	49%	44%	36%



EBV Analysis 2024-02-02

Logix Merit Index	105
Growth Index	111
Reproduction Index	103

SELLER REMARKS: Dragtig met tweeling van Falcon NB20-683 Lam 24 Maart

LOT 58 (F)



PHR 210182

PHR OOI PHR 210182

. Kuddeboek	SP	
Geb. dtm	2021-09-21	
Oud.	2.4 jaar	
Inteling	4.15%	
Geb. Status	2	
OEL	ILP	OPI
18.8m	-	108
Gelam	1	
Lammers	2	
Gespeen	2	

UMPUKANE DORMERS



Clocolan, Free State
peet@umpukane.co.za

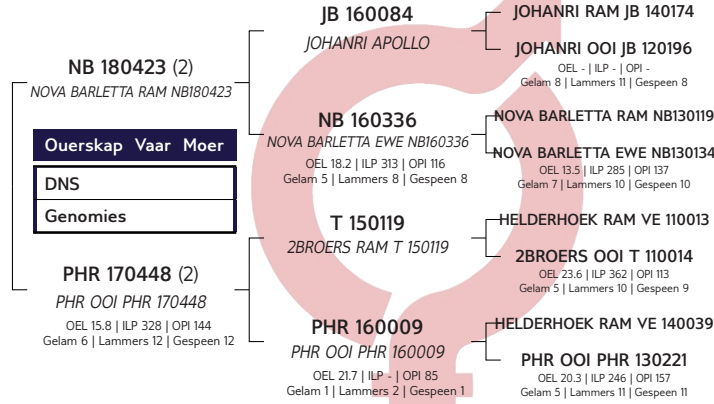

Groei			Reproduksie			
Spn. Dir.	Spn. Mat.	Na-Spn.	GLS	TWW	OEL	ILP
94	119	96	95	95	93	118
64%	62%	48%	44%	44%	43%	29%



EBV Analise 2024-02-02

Logix Meriete Indeks	104
Groei Indeks	107
Reproduksie Indeks	110

VERKOPER OPMERKINGS: Dragtig met tweeling van PHR220008 Lam vanaf 28 Maart

LOT 59 (F)



PHR 210138

PHR OOI PHR 210138

. Kuddeboek	SP	
Geb. dtm	2021-09-20	
Oud.	2.4 jaar	
Inteling	4.68%	
Geb. Status	2	
OEL	ILP	OPI
19m	-	99
Gelam	1	
Lammers	1	
Gespeen	1	

UMPUKANE DORMERS



Clocolan, Free State
peet@umpukane.co.za

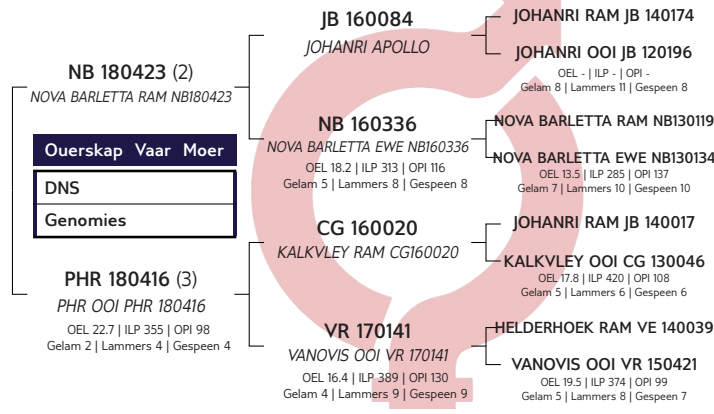

Groei			Reproduksie			
Spn. Dir.	Spn. Mat.	Na-Spn.	GLS	TWW	OEL	ILP
99	110	101	85	85	86	113
62%	58%	43%	44%	44%	44%	31%



EBV Analise 2024-02-02

Logix Meriete Indeks	97
Groei Indeks	107
Reproduksie Indeks	93

VERKOPER OPMERKINGS: Dragtig met eenling van PHR220008 Lam vanaf 28 Maart

LOT 60 (F)



PHR 220002

PHR OOI PHR 220002

. Kuddeboek	SP	
Geb. dtm	2022-04-08	
Oud.	1.9 jaar	
Inteling	6.06%	
Geb. Status	2	
OEL	ILP	OPI
-	-	-

UMPUKANE DORMERS



Clocolan, Free State
peet@umpukane.co.za

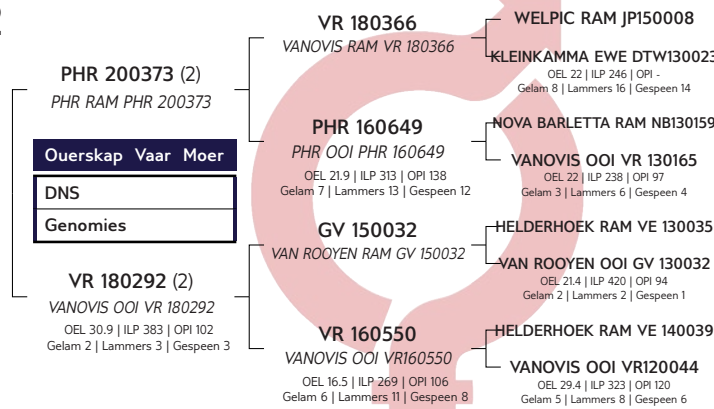

Groei			Reproduksie			
Spn. Dir.	Spn. Mat.	Na-Spn.	GLS	TWW	OEL	ILP
116	90	114	96	96	105	100
61%	50%	41%	36%	36%	35%	24%



EBV Analise 2024-02-02

Logix Meriete Indeks	111
Groei Indeks	114
Reproduksie Indeks	98

VERKOPER OPMERKINGS: Dragtig met drieling van JB21-174 Lam vanaf 28 Maart



LOT 61 (F)



UMPUKANE DORMERS
Clocolan, Free State
peet@umpukane.co.za

PHR 220037

PHR OOI PHR 220037



Herd Book	SP	
Birth date	2022-04-15	
Age	1.9 years	
Inbreeding	4.82%	
Birth Stat.	3	
AFL	ILP	EPI
18.1m	-	87
Lambled	1	
Lambs	1	
Weaned	0	

PHR 200373 (2)
PHR RAM PHR 200373

Parentage Sire Dam
DNA
Genomic

PHR 180400 (2)
PHR OOI PHR 180400
AFL 28.4 | ILP 372 | EPI 115
Lambled 3 | Lambs 7 | Weaned 7

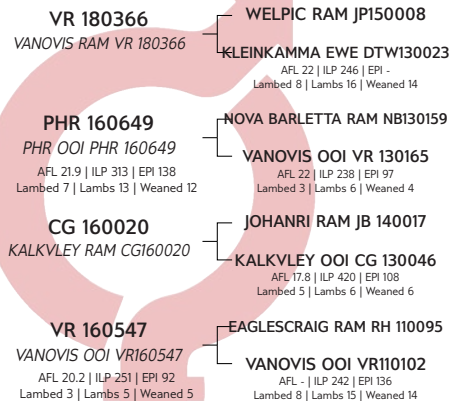

Growth			Reproduction			
Wn. Dir.	Wean Mat.	Post-Wn.	NLW	TWW	AFL	ILP
110	97	113	106	106	103	107
61%	52%	40%	37%	37%	41%	24%



EBV Analysis 2024-02-02

Logix Merit Index	115
Growth Index	111
Reproduction Index	111

SELLER REMARKS: Dragtig met eenling van PHR220094 Lam vanaf 28 Maart

LOT 62 (F)



UMPUKANE DORMERS
Clocolan, Free State
peet@umpukane.co.za

PHR 210243

PHR OOI PHR 210243



Herd Book	SP	
Birth date	2021-10-04	
Age	2.4 years	
Inbreeding	6.26%	
Birth Stat.	2	
AFL	ILP	EPI
18.2m	-	98
Lambled	1	
Lambs	1	
Weaned	1	

JP 190145 (1)
WELPIC RAM JP190145

Parentage Sire Dam
DNA
Genomic

PHR 200272 (2)
PHR OOI PHR 200272
AFL 17.8 | ILP - | EPI 87
Lambled 1 | Lambs 2 | Weaned 1

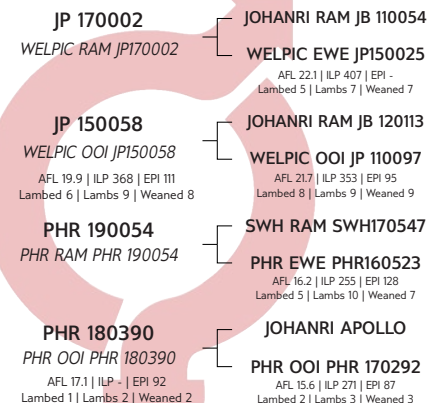

Growth			Reproduction			
Wn. Dir.	Wean Mat.	Post-Wn.	NLW	TWW	AFL	ILP
96	96	93	97	97	101	111
57%	48%	30%	34%	34%	36%	23%



EBV Analysis 2024-02-02

Logix Merit Index	97
Growth Index	97
Reproduction Index	98

SELLER REMARKS: Dragtig met tweeling van JB21-174 Lam vanaf 28 Maart

LOT 63 (F)



NOVA BARLETTA BOERDERY
Clocolan, Free State
0725976047
novabarletta@gmail.com

NB 200404

NOVA BARLETTA EWE NB200404



Herd Book	SP	
Birth date	2020-04-29	
Age	3.8 years	
Inbreeding	4.95%	
Birth Stat.	1	
AFL	ILP	EPI
14.3m	335d	111
Lambled	3	
Lambs	5	
Weaned	5	

JB 160084 (2)
JOHANRI APOLLO

Parentage Sire Dam
DNA
Genomic

NB 150299 (2)
NOVA BARLETTA EWE NB150299
AFL 18.2 | ILP 320 | EPI 107
Lambled 5 | Lambs 9 | Weaned 8

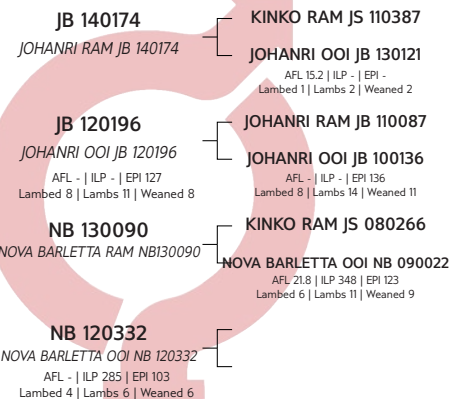

Growth			Reproduction			
Wn. Dir.	Wean Mat.	Post-Wn.	NLW	TWW	AFL	ILP
92	101	88	107	107	99	104
68%	71%	55%	58%	58%	55%	48%



EBV Analysis 2024-02-02

Logix Merit Index	101
Growth Index	96
Reproduction Index	109

SELLER REMARKS: Dragtig met tweeling van HE22-62 Lam 24 Maart

LOT 64 (F)



NOVA BARLETTA BOERDERY
Clocolan, Free State
0725976047
novabarletta@gmail.com

NB 210070

NOVA BARLETTA EWE NB210070



Kuddeboek	SP	
Geb. dtm	2021-03-09	
Oud.	3 jaar	
Inteling	5.77%	
Geb. Status	2	
OEL	ILP	OPI
17.4m	304d	98
Gelam	2	
Lammers	3	
Gespeen	2	

NB 190462 (3)
NOVA BARLETTA RAM NB190462

Uerskap	Vaar	Moer
DNS		
Genomies		

NB 180790 (1)
NOVA BARLETTA EWE NB180790
OEL 17.7 | ILP 359 | OPI 119
Gelam 4 | Lammers 8 | Gespeen 8

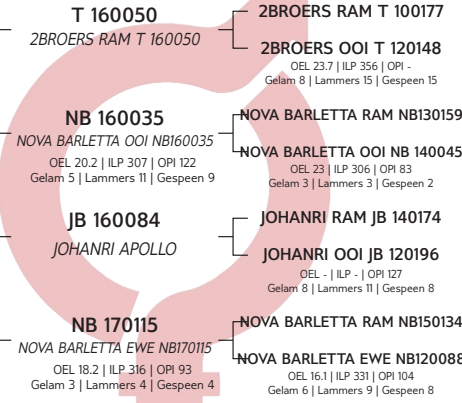

Groeï			Reproduksie			
Spn. Dir.	Spn. Mat.	Na-Spn.	GLS	TWW	OEL	ILP
101	96	95	112	112	116	104
65%	62%	50%	46%	46%	47%	37%



EBV Analise 2024-02-02

Logix Meriete Indeks	113
Groeï Indeks	102
Reproduksie Indeks	118

VERKOPER OPMERKINGS: Dragtig met tweeling van T22-332 Lam 24 Maart

LOT 65 (F)



NOVA BARLETTA BOERDERY
Clocolan, Free State
0725976047
novabarletta@gmail.com

NB 210648

NOVA BARLETTA EWE NB210648



Kuddeboek	SP	
Geb. dtm	2021-07-09	
Oud.	2.6 jaar	
Inteling	4.98%	
Geb. Status	1	
OEL	ILP	OPI
22m	-	99
Gelam	1	
Lammers	1	
Gespeen	1	

NB 190715 (2)
NOVA BARLETTA BUZZ

Uerskap	Vaar	Moer
DNS		
Genomies		

NB 190115 (1)
NOVA BARLETTA EWE NB190115
OEL 16.5 | ILP 326 | OPI 115
Gelam 4 | Lammers 6 | Gespeen 5

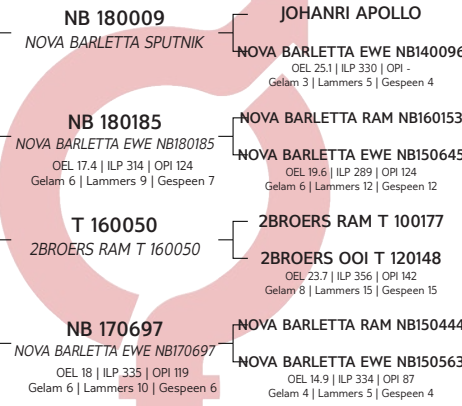

Groeï			Reproduksie			
Spn. Dir.	Spn. Mat.	Na-Spn.	GLS	TWW	OEL	ILP
111	90	104	110	110	114	102
63%	59%	43%	45%	45%	46%	28%



EBV Analise 2024-02-02

Logix Meriete Indeks	116
Groeï Indeks	109
Reproduksie Indeks	113

VERKOPER OPMERKINGS: Dragtig met tweeling van HE22-62 Lam 24 Maart

LOT 66 (F)



NOVA BARLETTA BOERDERY
Clocolan, Free State
0725976047
novabarletta@gmail.com

NB 210509

NOVA BARLETTA EWE NB210509



Kuddeboek	SP	
Geb. dtm	2021-05-20	
Oud.	2.8 jaar	
Inteling	4.45%	
Geb. Status	2	
OEL	ILP	OPI
22.6m	-	97
Gelam	1	
Lammers	1	
Gespeen	1	

JS 180231 (1)
KINKO RAM JS 180231

Uerskap	Vaar	Moer
DNS		
Genomies		

NB 170049 (2)
NOVA BARLETTA EWE NB170049
OEL 18.3 | ILP 344 | OPI 131
Gelam 6 | Lammers 11 | Gespeen 10

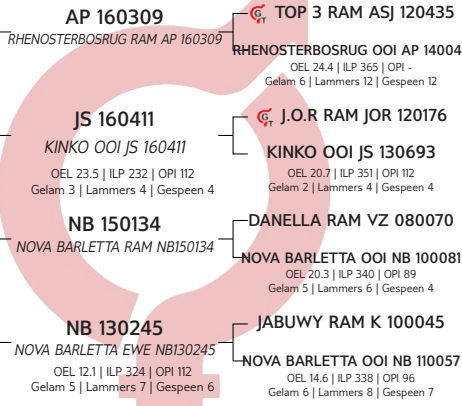

Groeï			Reproduksie			
Spn. Dir.	Spn. Mat.	Na-Spn.	GLS	TWW	OEL	ILP
109	88	110	109	109	97	107
65%	61%	51%	48%	48%	48%	30%



EBV Analise 2024-02-02

Logix Meriete Indeks	111
Groeï Indeks	106
Reproduksie Indeks	105

VERKOPER OPMERKINGS: Dragtig met tweeling van T22-332 Lam 24 Maart

LOT 67 (F)



NOVA BARLETTA BOERDERY

Clocolan, Free State
0725976047
novabarletta@gmail.com

NB 200006

NOVA BARLETTA EWE NB200006



Herd Book	SP	
Birth date	2020-03-03	
Age	4 years	
Inbreeding	5.53%	
Birth Stat.	1	
AFL	ILP	EPI
16.1m	336d	97
Lambd	3	
Lambs	5	
Weaned	3	

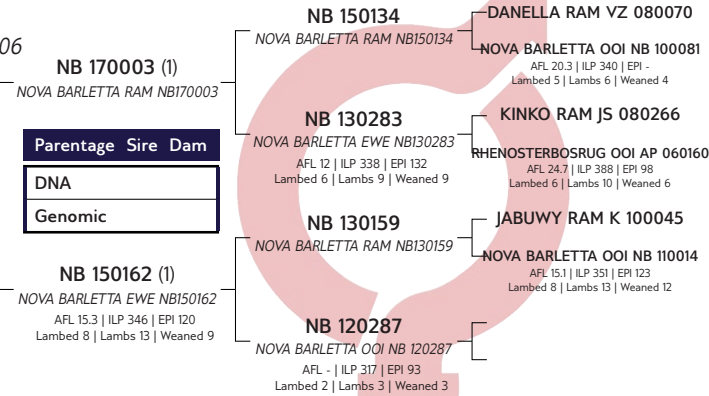

Growth			Reproduction			
Wn. Dir.	Wean Mat.	Post-Wn.	NLW	TWW	AFL	ILP
85	102	83	109	109	110	108
63%	63%	37%	46%	46%	41%	33%



EBV Analysis 2024-02-02

Logix Merit Index	99
Growth Index	90
Reproduction Index	114

SELLER REMARKS: Dragtig met tweeling van Falcon NB20-683 Lam 24 Maart

LOT 68 (F)



UMPUKANE DORMERS

Clocolan, Free State
peet@umpukane.co.za

PHR 220120

PHR OOI PHR 220120



Herd Book	SP	
Birth date	2022-10-08	
Age	1.4 years	
Inbreeding	4.74%	
Birth Stat.	2	
AFL	ILP	EPI
-	-	-

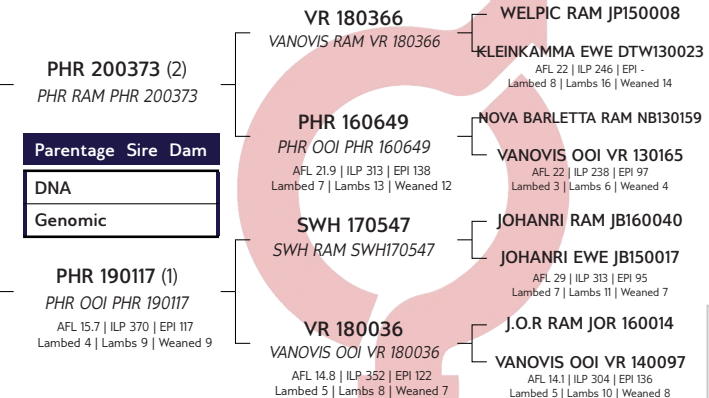

Growth			Reproduction			
Wn. Dir.	Wean Mat.	Post-Wn.	NLW	TWW	AFL	ILP
112	86	113	108	108	106	100
61%	52%	38%	37%	37%	35%	22%



EBV Analysis 2024-02-02

Logix Merit Index	113
Growth Index	108
Reproduction Index	106

SELLER REMARKS: Dragtig met tweeling van JB21-174 Lam vanaf 28 Maart

LOT 69 (F)



UMPUKANE DORMERS

Clocolan, Free State
peet@umpukane.co.za

PHR 220093

PHR OOI PHR 220093



Herd Book	SP	
Birth date	2022-10-02	
Age	1.4 years	
Inbreeding	5.37%	
Birth Stat.	2	
AFL	ILP	EPI
-	-	-

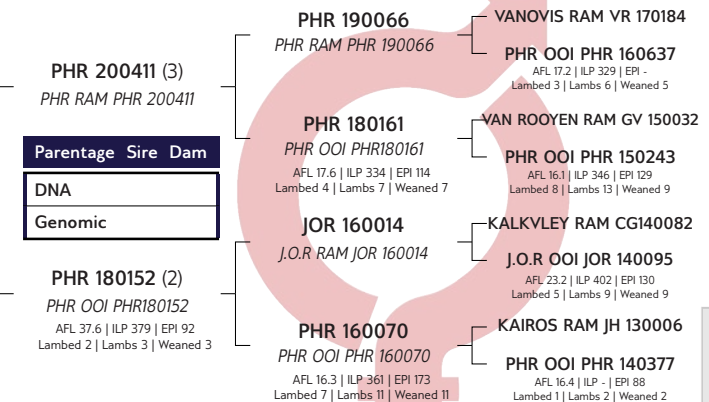

Growth			Reproduction			
Wn. Dir.	Wean Mat.	Post-Wn.	NLW	TWW	AFL	ILP
100	95	98	92	92	101	111
59%	43%	40%	30%	30%	23%	20%



EBV Analysis 2024-02-02

Logix Merit Index	98
Growth Index	100
Reproduction Index	95

SELLER REMARKS: Dragtig met eenling van PHR220008 Lam vanaf 28 Maart

LOT 70 (F)



UMPUKANE DORMERS
Clocolan, Free State
peet@umpukane.co.za

PHR 220097

PHR OOI PHR 220097



Kuddeboek	SP	
Geb. dtm	2022-10-03	
Oud.	1.4 jaar	
Inteling	4.13%	
Geb. Status	2	
OEL	ILP	OPI
-	-	-

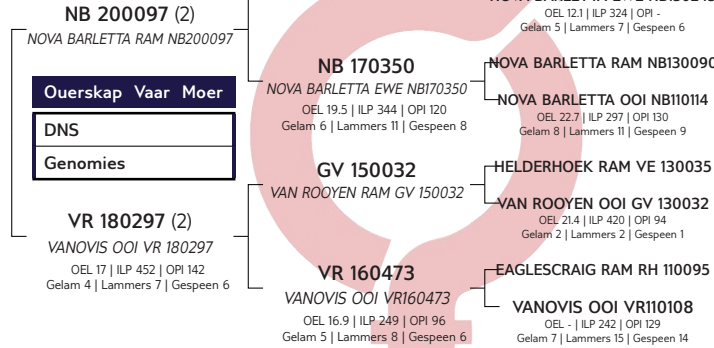

Groeï			Reproduksie			
Spn. Dir.	Spn. Mat.	Na-Spn.	GLS	TWW	OEL	ILP
99	107	95	82	82	99	103
57%	45%	35%	33%	33%	28%	25%



EBV Analise 2024-02-02

Logix Meriete Indeks	95
Groeï Indeks	105
Reproduksie Indeks	91

VERKOPER OPMERKINGS: Dragtig met tweeling van PHR220008 Lam vanaf 28 Maart

LOT 71 (F)



UMPUKANE DORMERS
Clocolan, Free State
peet@umpukane.co.za

PHR 220181

PHR OOI PHR 220181



Kuddeboek	SP	
Geb. dtm	2022-11-02	
Oud.	1.3 jaar	
Inteling	5.38%	
Geb. Status	2	
OEL	ILP	OPI
-	-	-

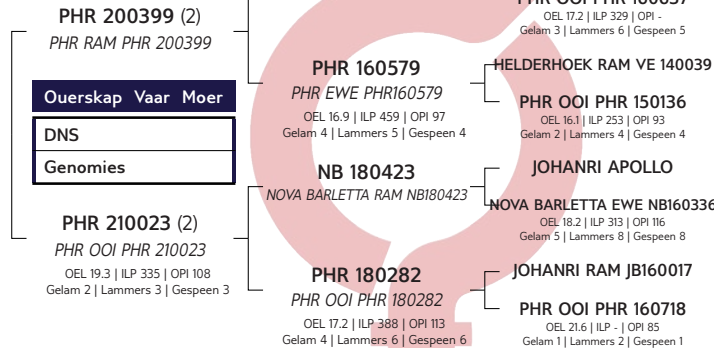

Groeï			Reproduksie			
Spn. Dir.	Spn. Mat.	Na-Spn.	GLS	TWW	OEL	ILP
108	99	105	86	86	99	101
57%	42%	34%	29%	29%	27%	20%



EBV Analise 2024-02-02

Logix Meriete Indeks	102
Groeï Indeks	111
Reproduksie Indeks	91

VERKOPER OPMERKINGS: Dragtig met tweeling van PHR220008 Lam vanaf 28 Maart

LOT 72 (F)



UMPUKANE DORMERS
Clocolan, Free State
peet@umpukane.co.za

PHR 220193

PHR OOI PHR 220193



Kuddeboek	SP	
Geb. dtm	2022-11-05	
Oud.	1.3 jaar	
Inteling	5.06%	
Geb. Status	2	
OEL	ILP	OPI
-	-	-

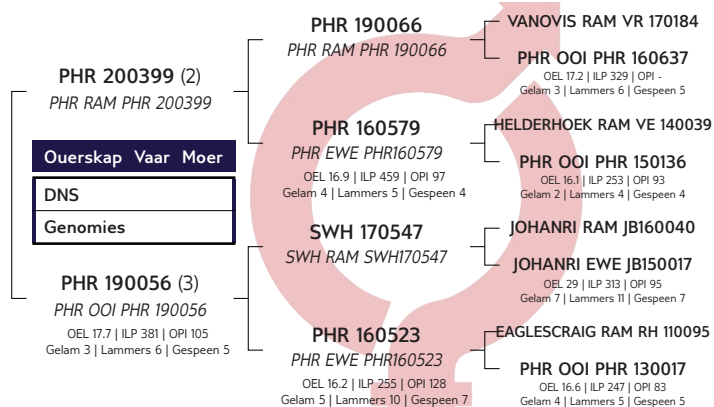

Groeï			Reproduksie			
Spn. Dir.	Spn. Mat.	Na-Spn.	GLS	TWW	OEL	ILP
107	101	105	91	91	101	95
58%	44%	34%	31%	31%	27%	22%



EBV Analise 2024-02-02

Logix Meriete Indeks	105
Groeï Indeks	111
Reproduksie Indeks	97

VERKOPER OPMERKINGS: Dragtig met eenling van PHR220008 Lam vanaf 28 Maart

LOT 73 (F)



NOVA BARLETTA BOERDERY

Clocolan, Free State
0725976047
novabarletta@gmail.com

NB 210220

NOVA BARLETTA EWE NB210220



Herd Book	SP	
Birth date	2021-03-10	
Age	3 years	
Inbreeding	3.81%	
Birth Stat.	3	
AFL	ILP	EPI
23.9m	-	97
Lambled	1	
Lambs	2	
Weaned	2	

JB 160084 (2)
JOHANRI APOLLO

Parentage Sire Dam
DNA
Genomic

NB 150570 (2)

NOVA BARLETTA EWE NB150570
AFL 14.9 | ILP 324 | EPI 123
Lambled 6 | Lambs 12 | Weaned 11

JB 140174
JOHANRI RAM JB 140174

JB 120196
JOHANRI OOI JB 120196
AFL - | ILP - | EPI 127
Lambled 8 | Lambs 11 | Weaned 8

NB 130033
NOVA BARLETTA RAM NB130033

NB 120008
NOVA BARLETTA EWE NB120008
AFL 17 | ILP 245 | EPI 115
Lambled 7 | Lambs 11 | Weaned 9

KINKO RAM JS 110387

JOHANRI OOI JB 130121
AFL 15.2 | ILP - | EPI -
Lambled 1 | Lambs 2 | Weaned 2

JOHANRI RAM JB 110087

JOHANRI OOI JB 100136
AFL - | ILP - | EPI 136
Lambled 8 | Lambs 14 | Weaned 11

J.O.R RAM JOR 100213

REMKUIL OOI JT 070308
AFL 25.3 | ILP 260 | EPI 85
Lambled 6 | Lambs 11 | Weaned 3

JABUWY RAM K 100045

NOVA BARLETTA EWE NB090031
AFL 19.2 | ILP 296 | EPI 101
Lambled 7 | Lambs 10 | Weaned 7

Growth			Reproduction			
Wn. Dir.	Wean Mat.	Post-Wn.	NLW	TWW	AFL	ILP
88	102	88	113	113	102	98
67%	67%	57%	57%	57%	55%	47%



EBV Analysis 2024-02-02

Logix Merit Index	101
Growth Index	92
Reproduction Index	114

SELLER REMARKS: Dragtig met tweeling van HE22-62 Lam 24 Maart

LOT 74 (F)



NOVA BARLETTA BOERDERY

Clocolan, Free State
0725976047
novabarletta@gmail.com

NB 210530

NOVA BARLETTA EWE NB210530



Herd Book	SP	
Birth date	2021-07-06	
Age	2.6 years	
Inbreeding	4.62%	
Birth Stat.	2	
AFL	ILP	EPI
22.1m	-	98
Lambled	1	
Lambs	1	
Weaned	1	

NB 190715 (2)

NOVA BARLETTA BUZZ

Parentage Sire Dam
DNA
Genomic

NB 190442 (3)

NOVA BARLETTA EWE NB190442
AFL 15.7 | ILP 341 | EPI 119
Lambled 4 | Lambs 8 | Weaned 6

NB 180009
NOVA BARLETTA SPUTNIK

NB 180185
NOVA BARLETTA EWE NB180185
AFL 17.4 | ILP 314 | EPI 124
Lambled 6 | Lambs 9 | Weaned 7

T 160050
2BROERS RAM T 160050

NB 140046
NOVA BARLETTA EWE NB140046
AFL 26.5 | ILP 355 | EPI 121
Lambled 5 | Lambs 10 | Weaned 8

JOHANRI APOLLO

NOVA BARLETTA EWE NB140096
AFL 25.1 | ILP 330 | EPI -
Lambled 3 | Lambs 5 | Weaned 4

NOVA BARLETTA RAM NB160153

NOVA BARLETTA EWE NB150645
AFL 19.6 | ILP 289 | EPI 124
Lambled 6 | Lambs 12 | Weaned 12

2BROERS RAM T 100177

2BROERS OOI T 120148
AFL 23.7 | ILP 356 | EPI 142
Lambled 8 | Lambs 15 | Weaned 15

2BROERS RAM T 120086

NOVA BARLETTA OOI NB 090019
AFL 14 | ILP 298 | EPI 136
Lambled 9 | Lambs 18 | Weaned 11

Growth			Reproduction			
Wn. Dir.	Wean Mat.	Post-Wn.	NLW	TWW	AFL	ILP
107	91	101	113	113	112	91
64%	59%	45%	45%	45%	47%	29%



EBV Analysis 2024-02-02

Logix Merit Index	113
Growth Index	106
Reproduction Index	113

SELLER REMARKS: Dragtig met tweeling van HE22-62 Lam 24 Maart

LOT 75 (F)



NOVA BARLETTA BOERDERY

Clocolan, Free State
0725976047
novabarletta@gmail.com

NB 210116

NOVA BARLETTA EWE NB210116



Herd Book	SP	
Birth date	2021-03-09	
Age	3 years	
Inbreeding	4.75%	
Birth Stat.	2	
AFL	ILP	EPI
24m	-	99
Lambled	1	
Lambs	2	
Weaned	2	

NB 190462 (3)

NOVA BARLETTA RAM NB190462

Parentage Sire Dam
DNA
Genomic

NB 180363 (2)

NOVA BARLETTA EWE NB180363
AFL 20.3 | ILP 360 | EPI 100
Lambled 3 | Lambs 5 | Weaned 5

T 160050
2BROERS RAM T 160050

NB 160035
NOVA BARLETTA OOI NB160035
AFL 20.2 | ILP 307 | EPI 122
Lambled 5 | Lambs 11 | Weaned 9

JB 160084
JOHANRI APOLLO

NB 150434
NOVA BARLETTA EWE NB150434
AFL 15.6 | ILP 325 | EPI 106
Lambled 5 | Lambs 8 | Weaned 6

2BROERS RAM T 100177

2BROERS OOI T 120148
AFL 23.7 | ILP 356 | EPI -
Lambled 8 | Lambs 15 | Weaned 15

NOVA BARLETTA RAM NB130159

NOVA BARLETTA OOI NB 140045
AFL 23 | ILP 306 | EPI 83
Lambled 3 | Lambs 3 | Weaned 2

JOHANRI RAM JB 140174

JOHANRI OOI JB 120196
AFL - | ILP - | EPI 127
Lambled 8 | Lambs 11 | Weaned 8

DANELLA RAM VZ 080070

NOVA BARLETTA OOI NB 110077
AFL 12.7 | ILP 315 | EPI 121
Lambled 8 | Lambs 14 | Weaned 13

Growth			Reproduction			
Wn. Dir.	Wean Mat.	Post-Wn.	NLW	TWW	AFL	ILP
98	95	94	107	107	112	102
64%	62%	53%	47%	47%	48%	35%



EBV Analysis 2024-02-02

Logix Merit Index	106
Growth Index	99
Reproduction Index	111

SELLER REMARKS: Dragtig met tweeling van T22-332 Lam 24 Maart

LOT 76 (F)



NOVA BARLETTA BOERDERY

Clocolan, Free State
0725976047
novabarletta@gmail.com

NB 210378

NOVA BARLETTA EWE NB210378



Kuddeboek	SP	
Geb. dtm	2021-05-16	
Oud.	2.8 jaar	
Inteling	4.73%	
Geb. Status	2	
OEL	ILP	OPI
22.8m	-	97
Gelam	1	
Lammers	1	
Gespeen	1	

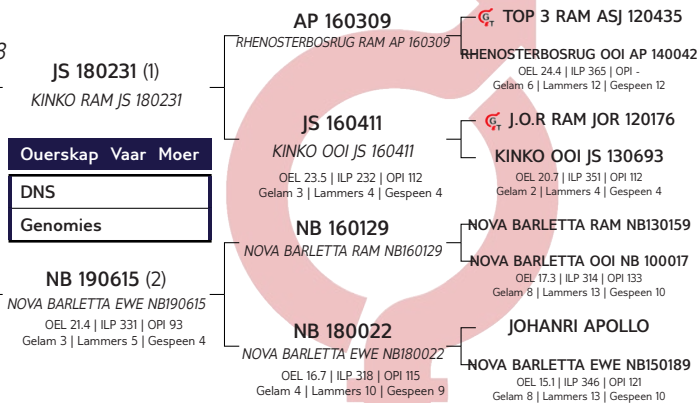

Groei			Reproduksie			
Spn. Dir.	Spn. Mat.	Na-Spn.	GLS	TWW	OEL	ILP
104	81	104	112	112	100	114
63%	59%	50%	46%	46%	47%	30%



EBV Analise 2024-02-02

Logix Meriete Indeks **106**

Groei Indeks **97**

Reproduksie Indeks **103**

VERKOPER OPMERKINGS: Dragtig met tweeling van T22-332 Lam 24 Maart

LOT 77 (F)



NOVA BARLETTA BOERDERY

Clocolan, Free State
0725976047
novabarletta@gmail.com

NB 210018

NOVA BARLETTA EWE NB210018



Kuddeboek	SP	
Geb. dtm	2021-03-07	
Oud.	3 jaar	
Inteling	6.41%	
Geb. Status	1	
OEL	ILP	OPI
24m	-	94
Gelam	1	
Lammers	2	
Gespeen	1	

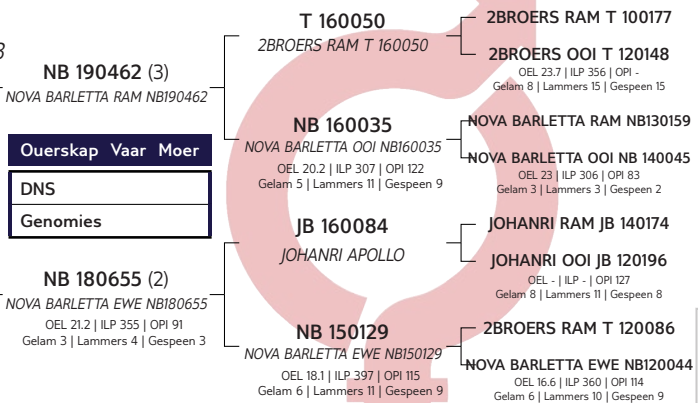

Groei			Reproduksie			
Spn. Dir.	Spn. Mat.	Na-Spn.	GLS	TWW	OEL	ILP
100	94	94	97	97	111	103
63%	59%	52%	46%	46%	48%	35%



EBV Analise 2024-02-02

Logix Meriete Indeks **102**

Groei Indeks **100**

Reproduksie Indeks **101**

VERKOPER OPMERKINGS: Dragtig met tweeling van HE22-62 Lam 24 Maart

LOT 78 (F)



UMPUKANE DORMERS

Clocolan, Free State
peet@umpukane.co.za

PHR 220200

PHR OOI PHR 220200



Kuddeboek	SP	
Geb. dtm	2022-11-07	
Oud.	1.3 jaar	
Inteling	4.95%	
Geb. Status	2	
OEL	ILP	OPI
-	-	-

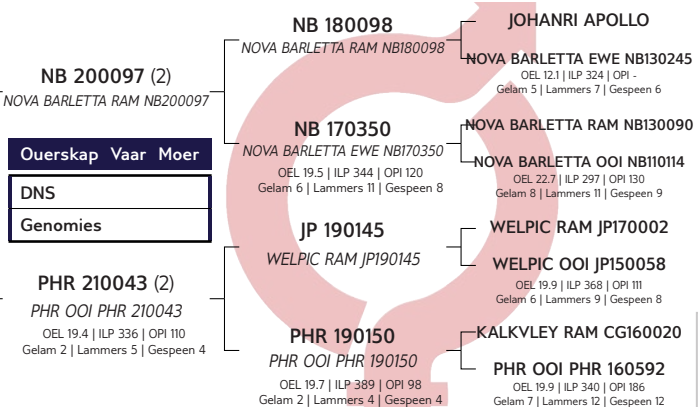

Groei			Reproduksie			
Spn. Dir.	Spn. Mat.	Na-Spn.	GLS	TWW	OEL	ILP
102	97	97	97	97	100	109
56%	41%	28%	30%	30%	27%	22%



EBV Analise 2024-02-02

Logix Meriete Indeks **103**

Groei Indeks **103**

Reproduksie Indeks **100**

VERKOPER OPMERKINGS: Dragtig met tweeling van PHR220094 Lam vanaf 28 Maart



LOT 79 (F)



UMPUKANE DORMERS
Clocolan, Free State
peet@umpukane.co.za



PHR 220105

PHR OOI PHR 220105

Herd Book	SP	
Birth date	2022-10-05	
Age	1.4 years	
Inbreeding	6.17%	
Birth Stat.	1	
AFL	ILP	EPI
-	-	-

PHR 200373 (2)
PHR RAM PHR 200373

Parentage	Sire	Dam
DNA		
Genomic		

PHR 200191 (2)
PHR OOI PHR 200191
AFL 20.4 | ILP 379 | EPI 97
Lambd 2 | Lams 2 | Weaned 2

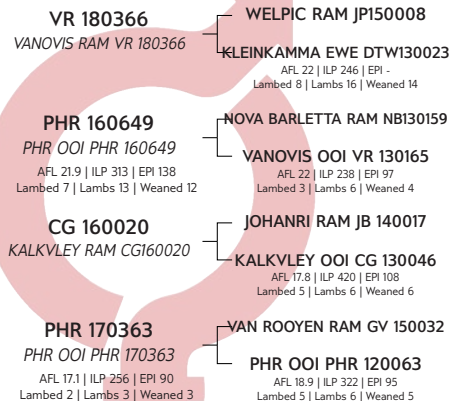

Growth			Reproduction			
Wn. Dir.	Wean Mat.	Post-Wn.	NLW	TWW	AFL	ILP
118	94	120	90	90	104	103
60%	49%	38%	37%	37%	37%	24%



EBV Analysis 2024-02-02

Logix Merit Index	112
Growth Index	118
Reproduction Index	97

SELLER REMARKS: Dragtig met drieling van JB21-174 Lam vanaf 28 Maart

LOT 80 (F)



UMPUKANE DORMERS
Clocolan, Free State
peet@umpukane.co.za



PHR 220180

PHR OOI PHR 220180

Herd Book	SP	
Birth date	2022-11-01	
Age	1.3 years	
Inbreeding	4.32%	
Birth Stat.	2	
AFL	ILP	EPI
-	-	-

PHR 200373 (2)
PHR RAM PHR 200373

Parentage	Sire	Dam
DNA		
Genomic		

PHR 170448 (2)
PHR OOI PHR 170448
AFL 15.8 | ILP 328 | EPI 144
Lambd 6 | Lams 12 | Weaned 12

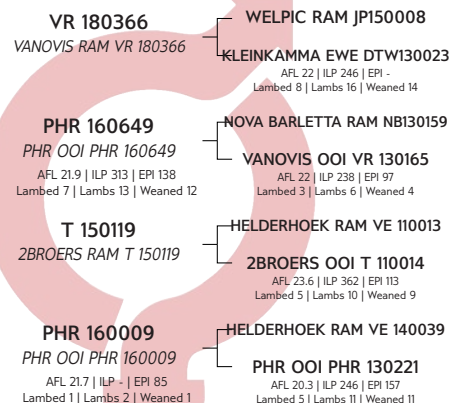

Growth			Reproduction			
Wn. Dir.	Wean Mat.	Post-Wn.	NLW	TWW	AFL	ILP
107	95	108	112	112	108	109
62%	53%	42%	37%	37%	35%	22%



EBV Analysis 2024-02-02

Logix Merit Index	116
Growth Index	108
Reproduction Index	116

SELLER REMARKS: Dragtig met eenling van JB21-174 Lam vanaf 28 Maart

LOT 81 (F)



UMPUKANE DORMERS
Clocolan, Free State
peet@umpukane.co.za



PHR 220080

PHR OOI PHR 220080

Herd Book	SP	
Birth date	2022-09-26	
Age	1.4 years	
Inbreeding	8.97%	
Birth Stat.	1	
AFL	ILP	EPI
-	-	-

NB 200097 (2)
NOVA BARLETTA RAM NB200097

Parentage	Sire	Dam
DNA		
Genomic		

PHR 210014 (2)
PHR OOI PHR 210014
AFL 18.1 | ILP - | EPI 91
Lambd 1 | Lams 1 | Weaned 1

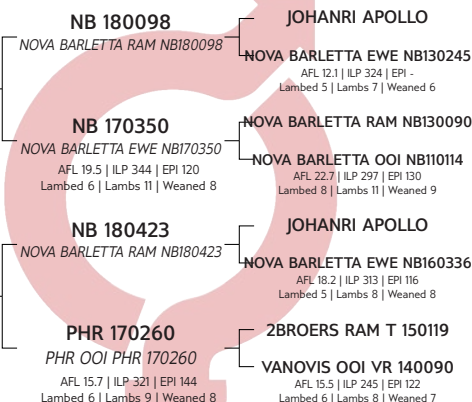

Growth			Reproduction			
Wn. Dir.	Wean Mat.	Post-Wn.	NLW	TWW	AFL	ILP
101	107	97	82	82	96	107
56%	40%	34%	31%	31%	29%	23%



EBV Analysis 2024-02-02

Logix Merit Index	97
Growth Index	107
Reproduction Index	91

SELLER REMARKS: Dragtig met tweeling van PHR220008 Lam vanaf 28 Maart

LOT 82 (F)



PHR 220141

PHR OOI PHR 220141

Kuddeboek	SP	
Geb. dtm	2022-10-16	
Oud.	1.4 jaar	
Inteling	5.57%	
Geb. Status	3	
OEL	ILP	OPI
-	-	-

UMPUKANE DORMERS



Clocolan, Free State
peet@umpukane.co.za

PHR 200373 (2)
PHR RAM PHR 200373

Ouerskap	Vaar	Moer
DNS		
Genomies		

PHR 190011 (2)
PHR OOI PHR 190011
OEL 17.8 | ILP 368 | OPI 112
Gelam 4 | Lammers 7 | Gespeen 6

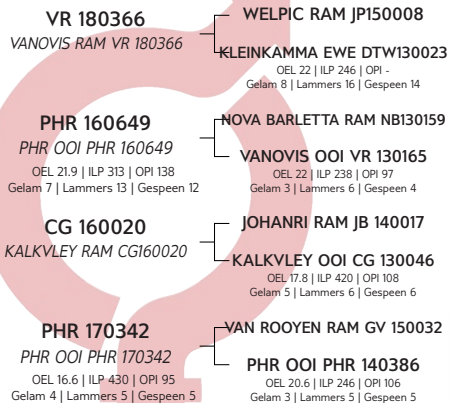

Groei			Reproduksie			
Spn. Dir.	Spn. Mat.	Na-Spn.	GLS	TWW	OEL	ILP
119	92	118	88	88	105	101
61%	52%	38%	38%	38%	37%	24%



Logix Meriete Indeks	111
Groei Indeks	118
Reproduksie Indeks	94

VERKOPER OPMERKINGS: Dragtig met tweeling van JB21-174 Lam vanaf 28 Maart

MALUTI DORMERS - KOMMERSIËLE OOIE

83	Nova Barletta 10 Tweeling ooie	Jong ooie	Lam 27 April van VOV ramme
84	Nova Barletta 15 Tweeling ooie	Jong ooie	Lam 27 April van VOV ramme
85	Nova Barletta 5 Tweeling ooie	Jong ooie	Lam 27 April van VOV ramme
86	Nova Barletta 15 Tweeling ooie	Jong ooie	Lam 27 April van VOV ramme
87	Nova Barletta 15 Tweeling ooie	Jong ooie	Lam 27 April van VOV ramme
88	Umpukane 10 Tweeling ooie	Jong ooie	Lam vanaf 28 Maart
89	Umpukane 10 Tweeling ooie	Jong ooie	Lam vanaf 28 Maart
90	Umpukane 10 Tweeling ooie	Jong ooie	Lam vanaf 28 Maart
91	Umpukane 15 Tweeling ooie	Jong ooie	Lam vanaf 28 Maart
92	Umpukane 15 Eenling ooie	Jong ooie	Lam vanaf 28 Maart
93	Nova Barletta 15 Tweeling ooie	Jong ooie	Lam 27 April van VOV ramme
94	Nova Barletta 10 Tweeling ooie	Jong ooie	Lam 27 April van VOV ramme
95	Nova Barletta 15 Tweeling ooie	Jong ooie	Lam 27 April van VOV ramme
96	Nova Barletta 15 Tweeling ooie	Jong ooie	Lam 27 April van VOV ramme
97	Nova Barletta 5 Eenling ooie	Jong ooie	Lam 27 April van VOV ramme
98	Umpukane 15 Tweeling ooie	4/6 Tand ooie	Lam vanaf 28 Maart
99	Umpukane 10 Tweeling ooie	4/6 Tand ooie	Lam vanaf 28 Maart
100	Umpukane 10 Eenling ooie	4/6 Tand ooie	Lam vanaf 28 Maart
101	Umpukane 15 Eenling ooie	Jong ooie	Lam vanaf 28 Maart
102	Umpukane 15 Eenling ooie	Jong ooie	Lam vanaf 28 Maart
103	Nova Barletta 15 Tweeling ooie	Jong ooie	Lam 27 April van VOV ramme
104	Nova Barletta 15 Eenling ooie	Jong ooie	Lam 27 April van VOV ramme
105	Nova Barletta 5 Tweeling ooie	Jong ooie	Lam 27 April van VOV ramme
106	Nova Barletta 15 Eenling ooie	Jong ooie	Lam 27 April van VOV ramme
107	Umpukane 10 Oop ooie	11 Maande	Gereed vir die ram.
108	Umpukane 10 Oop ooie	11 Maande	Gereed vir die ram.
109	Umpukane 10 Oop ooie	11 Maande	Gereed vir die ram.

BAIE DANKIE AAN ONS BORGE



Voermol



SAAM BEREIK ONS MEER
TOGETHER WE ACHIEVE MORE



**BAIE DANKIE
DAT U DEEL
WAS VAN ONS
VEILING!**

SIEN U WEER!